



TDA Series

AXIAL FLOW FAN



Axial Flow Fan (Direct Driven) – TDA Series



Material

Double flanged casing is produced in mild steel or galvanized steel, impeller blades are available in PAG, PPG or Aluminum material.

Finish

Painting or galvanized after manufacture is normal finish on all parts.

Operating Temperature

- General ventilation: -20 to +55°C.
- Smoke exhaust: 250°C/300°C/400°C - 1~2 hours. (TÜV SÜD certified)

Motors

- General ventilation: Totally Enclosed Fan Cooled (TEFC), Class "F".
- Smoke exhaust system: Totally Enclosed Fan Cooled High Temperature Rated (250°C/300°C/400°C TÜV SÜD certified), IP55 protection. Standard motors up to 2.2kW are supplied with DOL starting. Motors 3.0kW and above are with star/delta starting. Motors of other specification are available upon request.

Airflow Direction

Air flow from impeller to motor is fitted as standard.

Certification



Kruger Ventilation Industries Asia Co., Ltd certifies that the TDA Series shown herein is licensed to bear the AMCA Seal. The ratings shown are based on tests and procedures performed in accordance with AMCA publication 211 and comply with the requirements of the AMCA Certified Rating Program.



Certified by **TÜV SÜD** which is a leading international service organization focusing on consulting, testing, certification and training.

TDA series was tested in accordance with EN 12101-3:2015.

Class	Temperature (°C)	Minimum functioning period (minutes)
F300	300	60
F400	400	120
F _f 250	250	120
F _f 300	300	120

Nomenclature

MODEL: TDA 630 / 12AA / 7-7 / 12° / PPG / F (400°C / 2hrs)

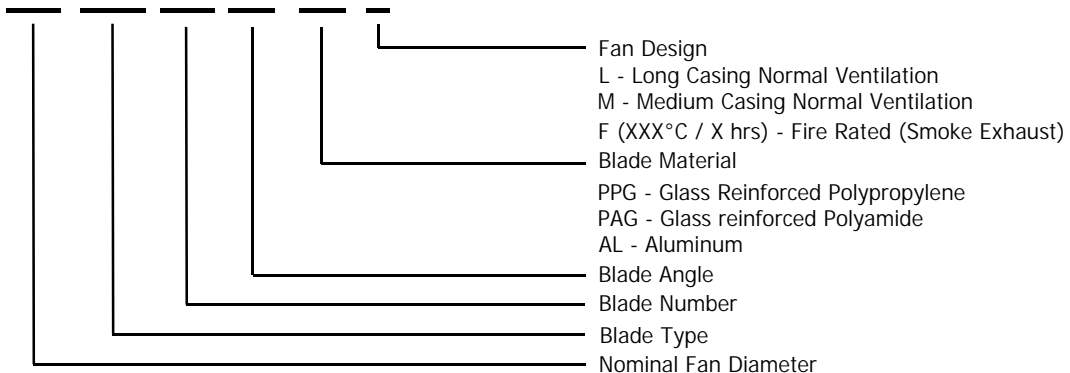

Dimension

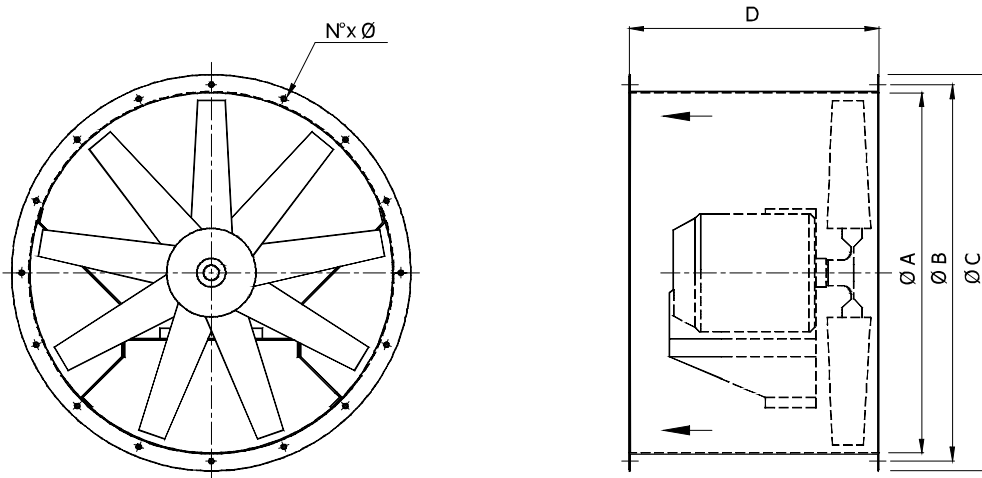

Model	A	B	C	D		N	Ø	Weight* (kg)		Max. Motor Frame Size**
				L/F Design	M Design			L/F Design	M Design	
630	630	675	730	500	346	12	10	24	18	D112M
710	710	755	810	500	406	18	12	40	30	D112M
800	800	845	900	560	406	18	12	49	40	D132M
900	900	945	1000	630	495	18	12	66	51	D160M
1000	1000	1050	1100	630	550	24	12	73	57	D160M
1120	1120	1185	1250	900	650	24	12	135	96	D225M
1250	1250	1315	1380	1000	700	24	12	170	147	D250M
1400	1400	1465	1530	1100	770	32	14	220	171	D250M
1600	1600	1663	1730	1250	-	32	14	275	-	D250M
1800	1800	1856	1930	1400	-	32	14	335	-	D280M
2000	2000	2073	2130	1400	-	32	14	380	-	D315M

*Weight without motor and impeller.

**Please consult KRUGER if motor frame size is beyond the catalogue range.

All Dimension in mm.

TDA630/12AA/7-7 50Hz



$\rho=1.2\text{kg/m}^3$
Hub: 186

FEG 71

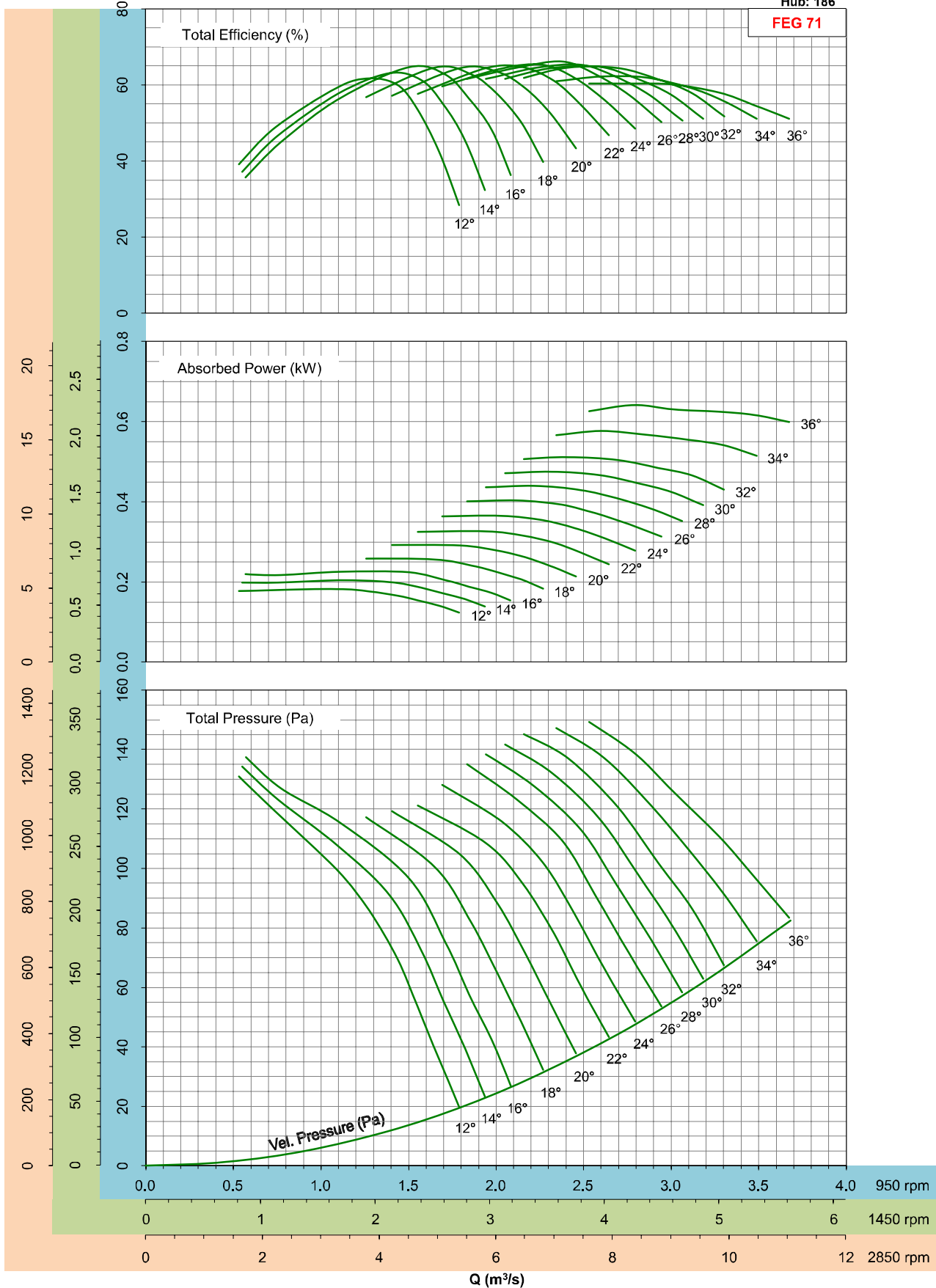

- Performance certified is for installation type D - ducted inlet, ducted outlet. Performance ratings do not include the effects of appurtenances (accessories).

- Please consult the nearest Kruger office for fan selection at 2900rpm.

TDA630/12AA/9-9 50Hz



$\rho=1.2\text{kg/m}^3$
Hub: 200

FEG 71

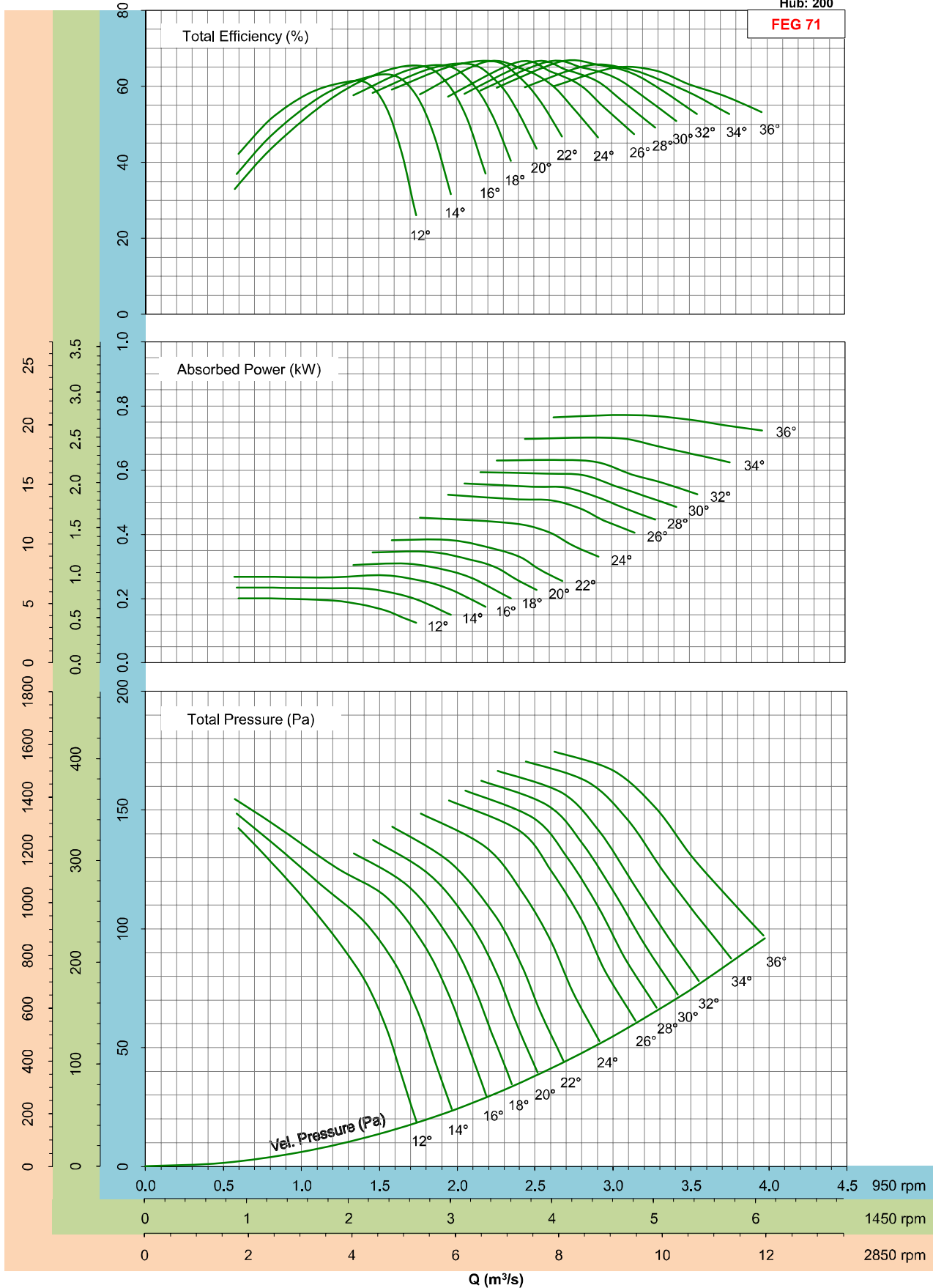

- Performance certified is for installation type D - ducted inlet, ducted outlet. Performance ratings do not include the effects of appurtenances (accessories).

- Please consult the nearest Kruger office for fan selection at 2900rpm.

TDA710/12AA/7-7 50Hz



$\rho=1.2\text{kg/m}^3$
Hub: 186

FEG 71

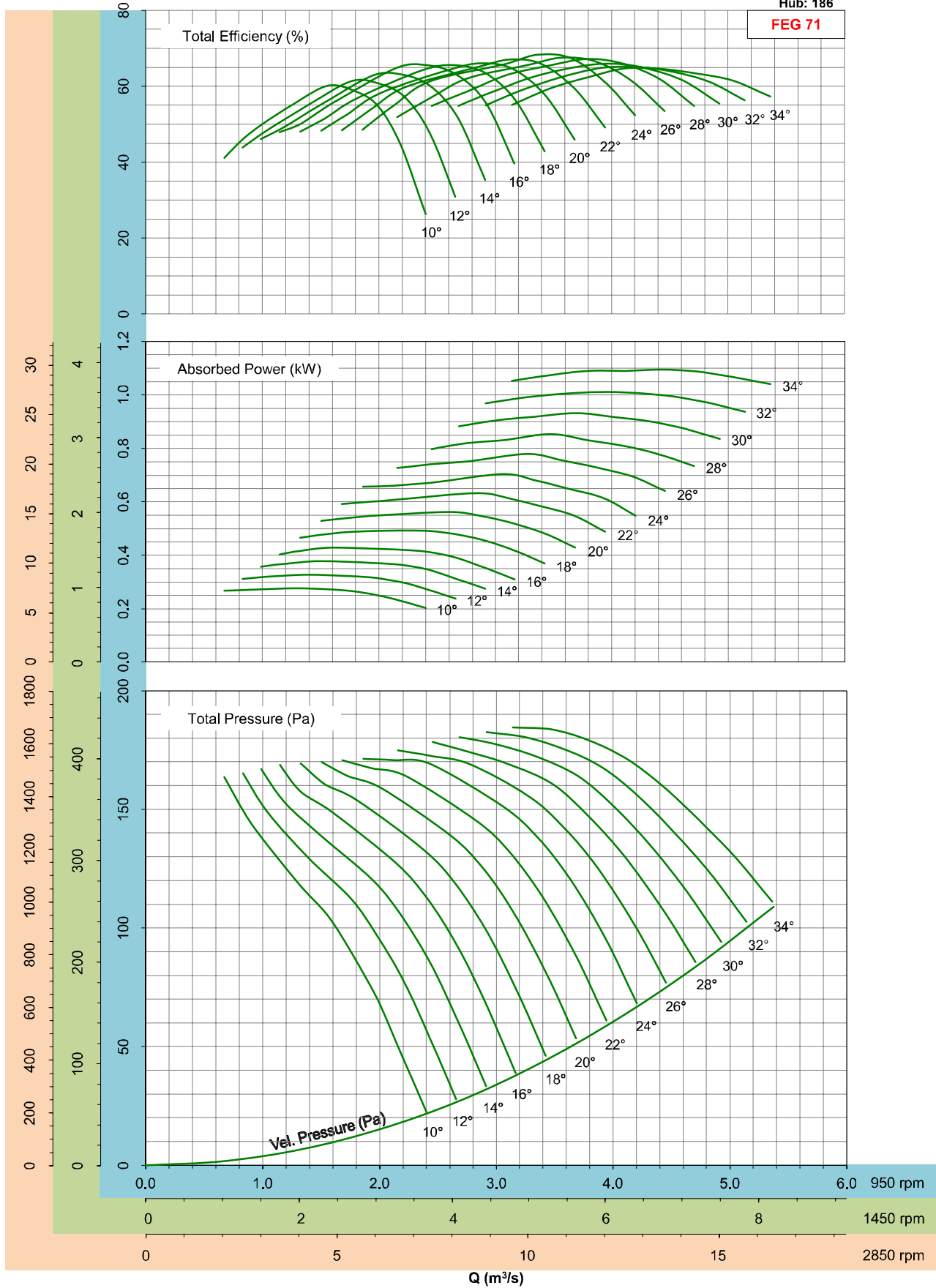

- Performance certified is for installation type D - ducted inlet, ducted outlet. Performance ratings do not include the effects of appurtenances (accessories).

- Please consult the nearest Kruger office for fan selection at 2900rpm.

TDA710/12AA/9-9 50Hz



$\rho=1.2\text{kg/m}^3$
Hub: 200

FEG 71

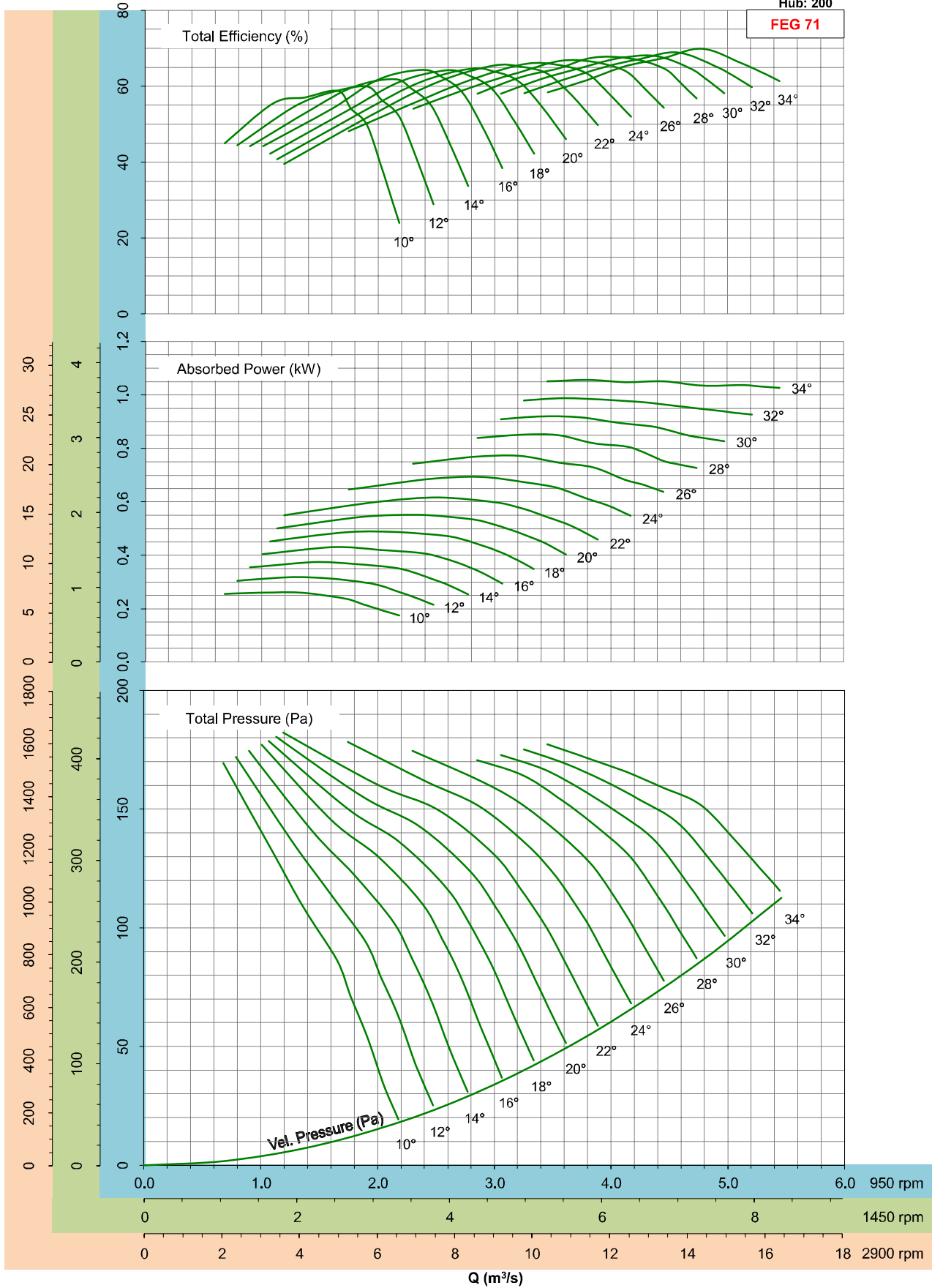

- Performance certified is for installation type D - ducted inlet, ducted outlet. Performance ratings do not include the effects of appurtenances (accessories).

- Please consult the nearest Kruger office for fan selection at 2900rpm.

TDA710/14AA/7-7 50Hz



$\rho=1.2\text{kg/m}^3$
Hub: 186

FEG 71

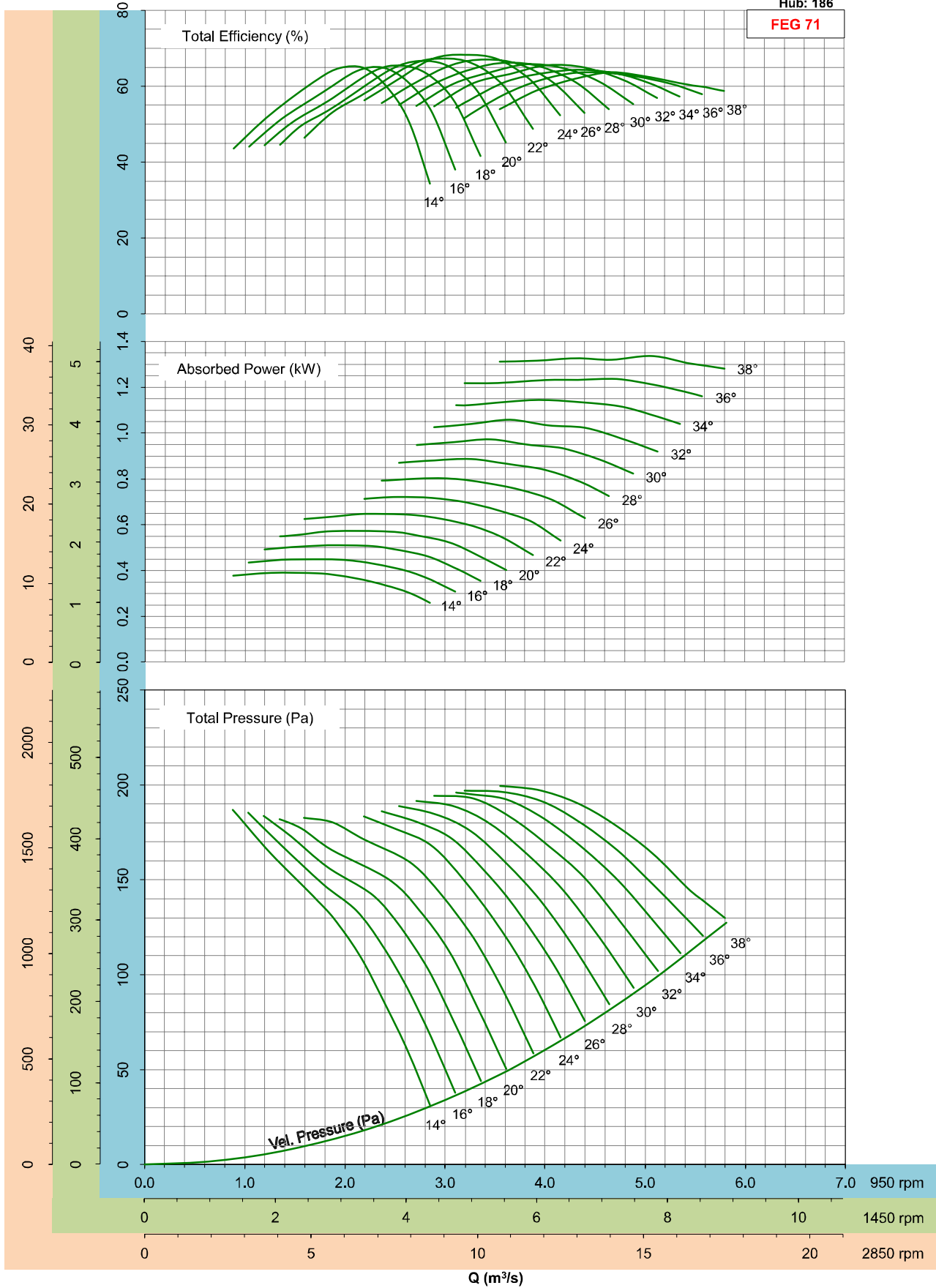

- Performance certified is for installation type D - ducted inlet, ducted outlet. Performance ratings do not include the effects of appurtenances (accessories).

- Please consult the nearest Kruger office for fan selection at 2900rpm.

TDA800/12AA/7-7 50Hz



$\rho=1.2\text{kg/m}^3$
Hub: 186

FEG 71

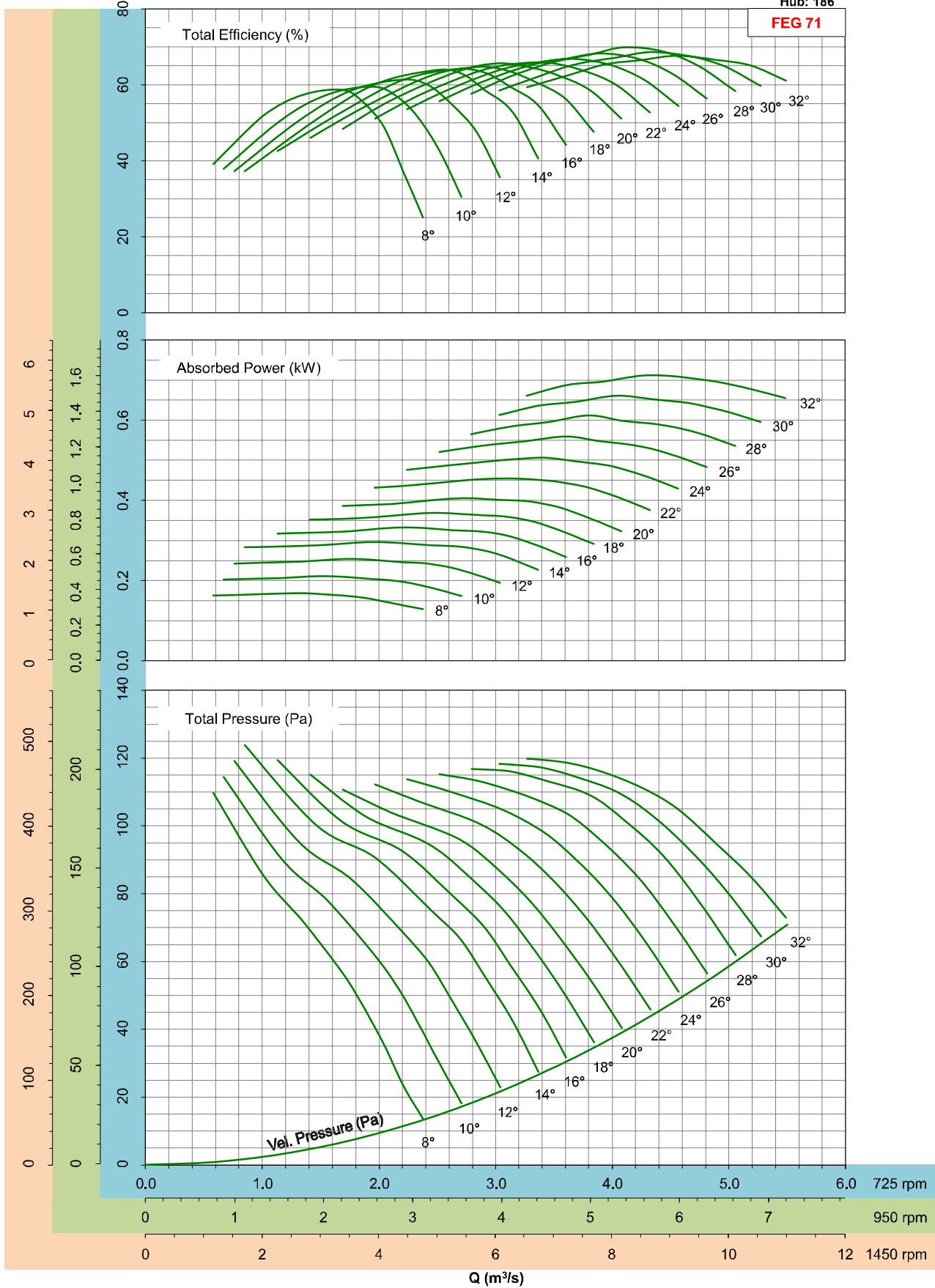

- Performance certified is for installation type D - ducted inlet, ducted outlet. Performance ratings do not include the effects of appurtenances (accessories).

TDA900/12AA/12-12 50Hz



$\rho=1.2\text{kg/m}^3$
Hub: 280

FEG 71

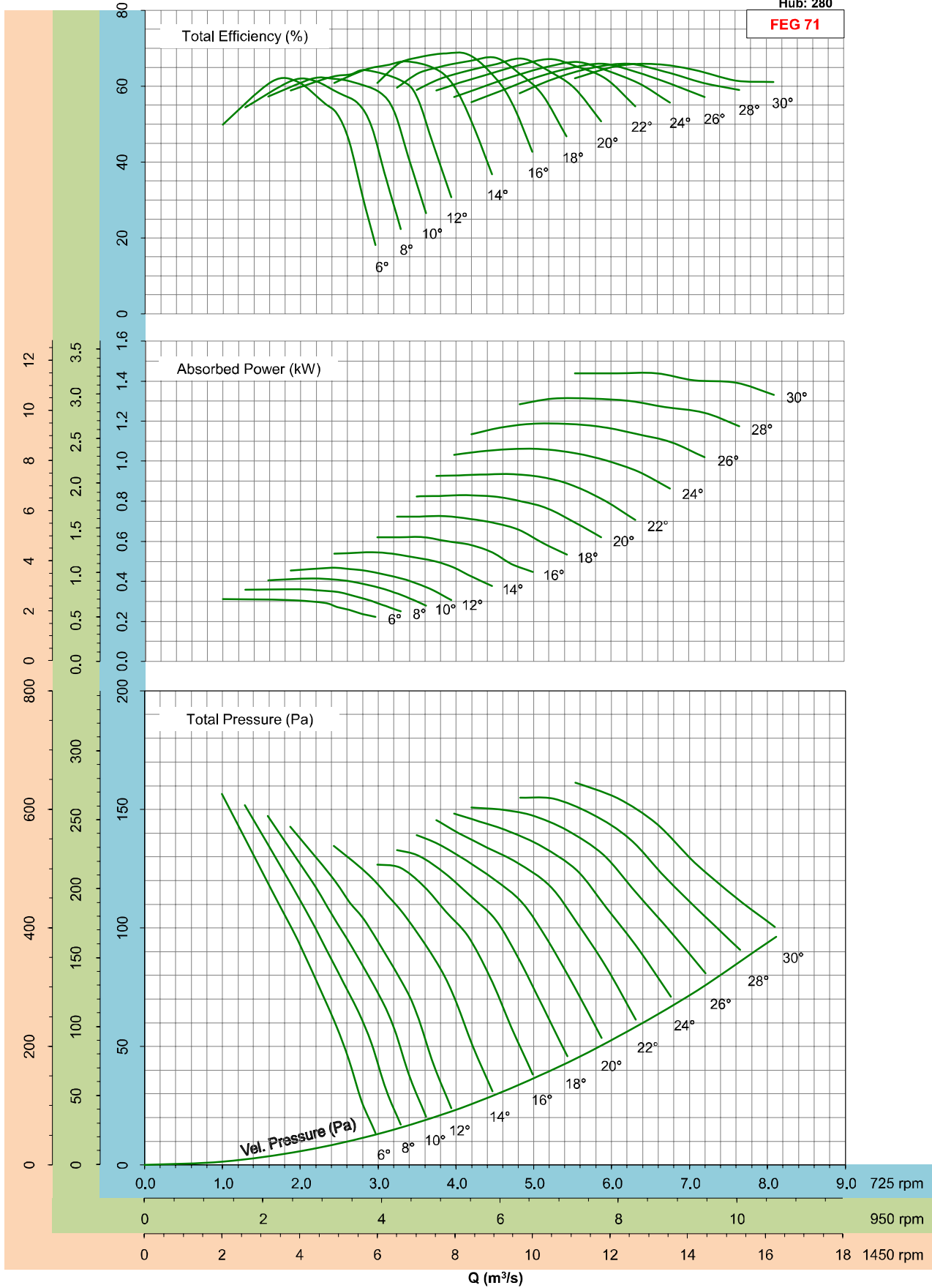

- Performance certified is for installation type D - ducted inlet, ducted outlet. Performance ratings do not include the effects of appurtenances (accessories).

TDA900/14AA/7-7 50Hz



$\rho=1.2\text{kg/m}^3$
Hub: 186

FEG 71

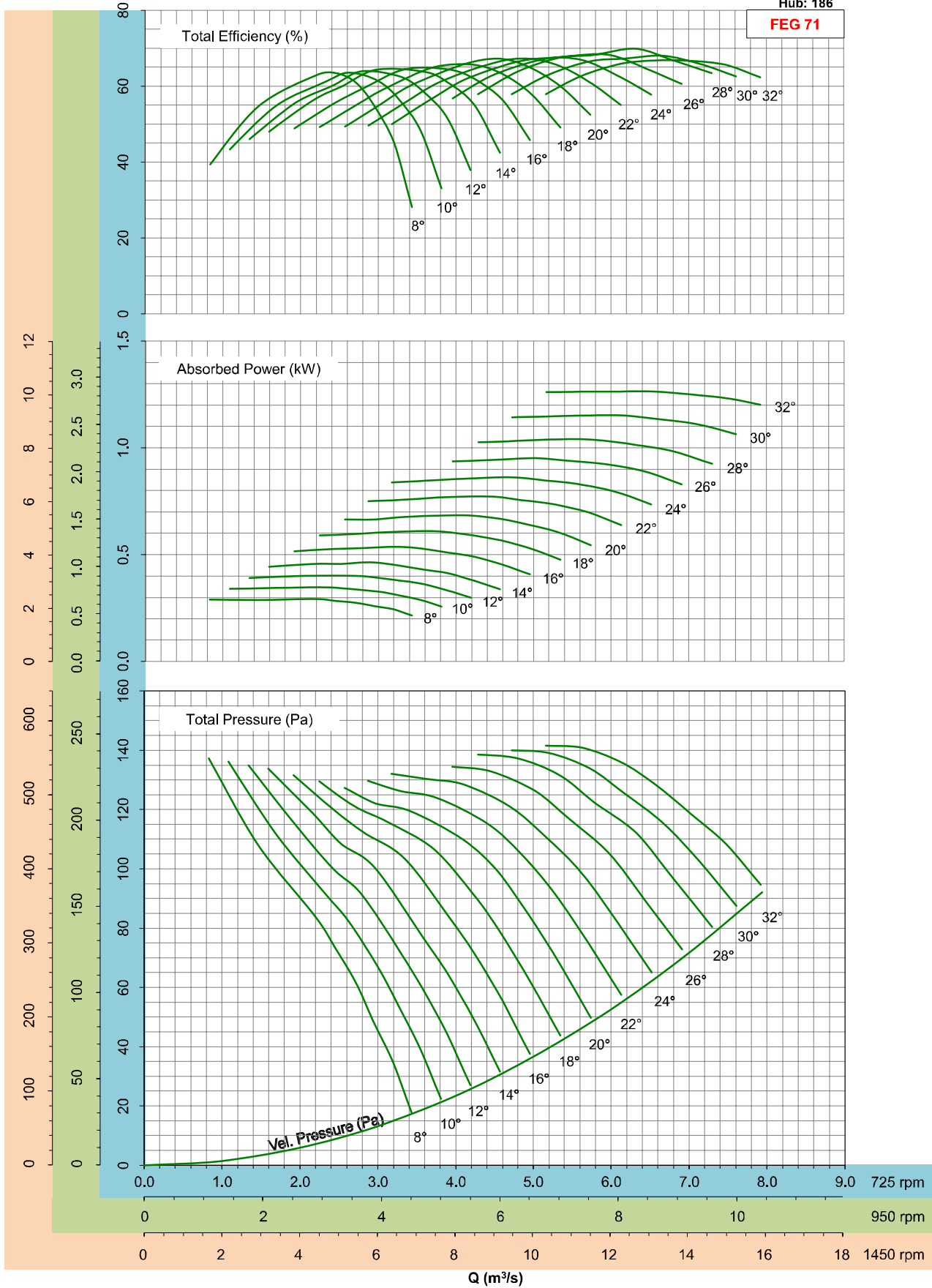

- Performance certified is for installation type D - ducted inlet, ducted outlet. Performance ratings do not include the effects of appurtenances (accessories).

TDA900/14AA/8-8 50Hz



$\rho=1.2\text{kg/m}^3$
Hub: 266

FEG 71

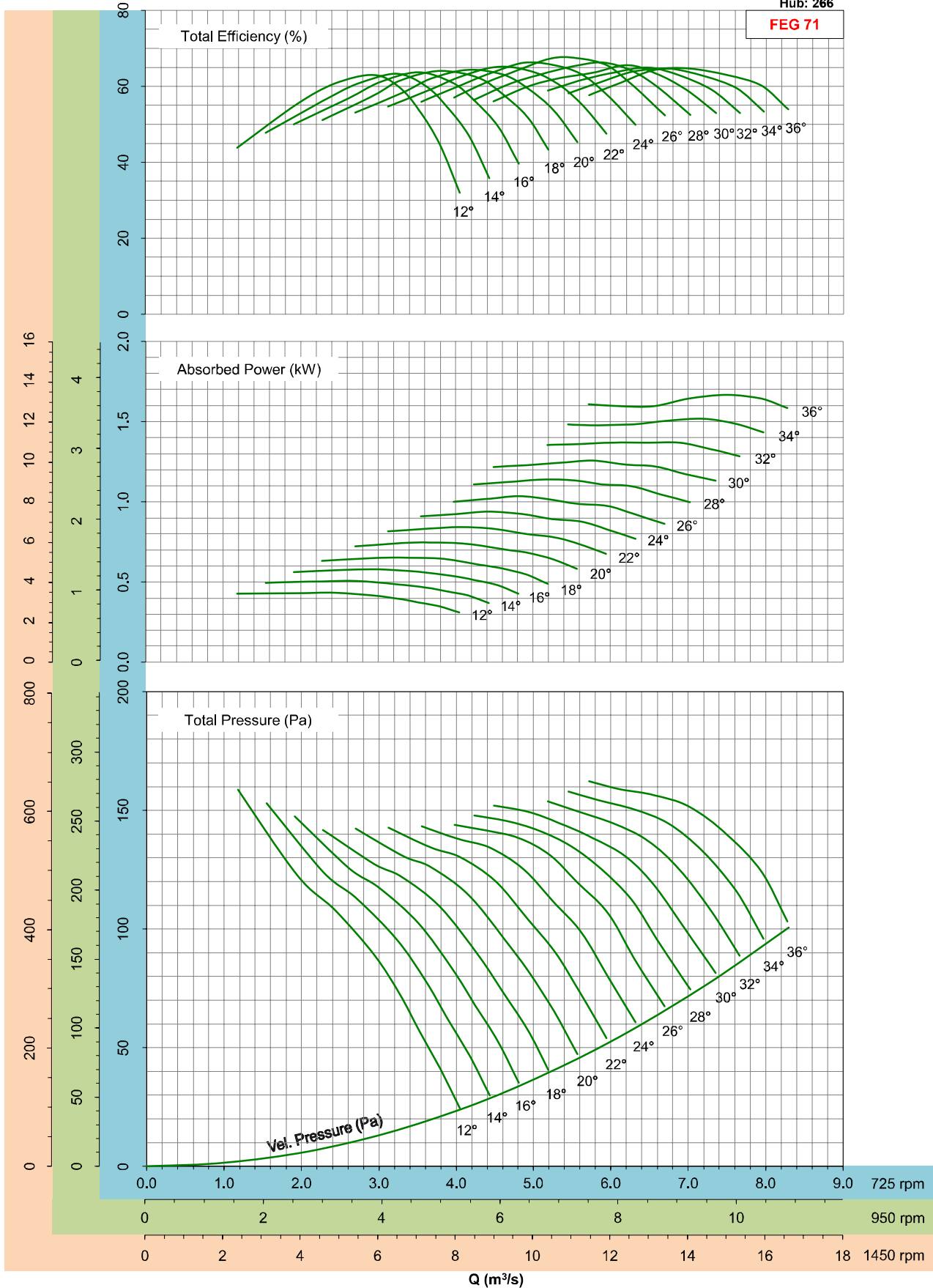

- Performance certified is for installation type D - ducted inlet, ducted outlet. Performance ratings do not include the effects of appurtenances (accessories).

TDA900/14AA/9-9 50Hz



$\rho=1.2\text{kg/m}^3$
Hub: 200

FEG 71

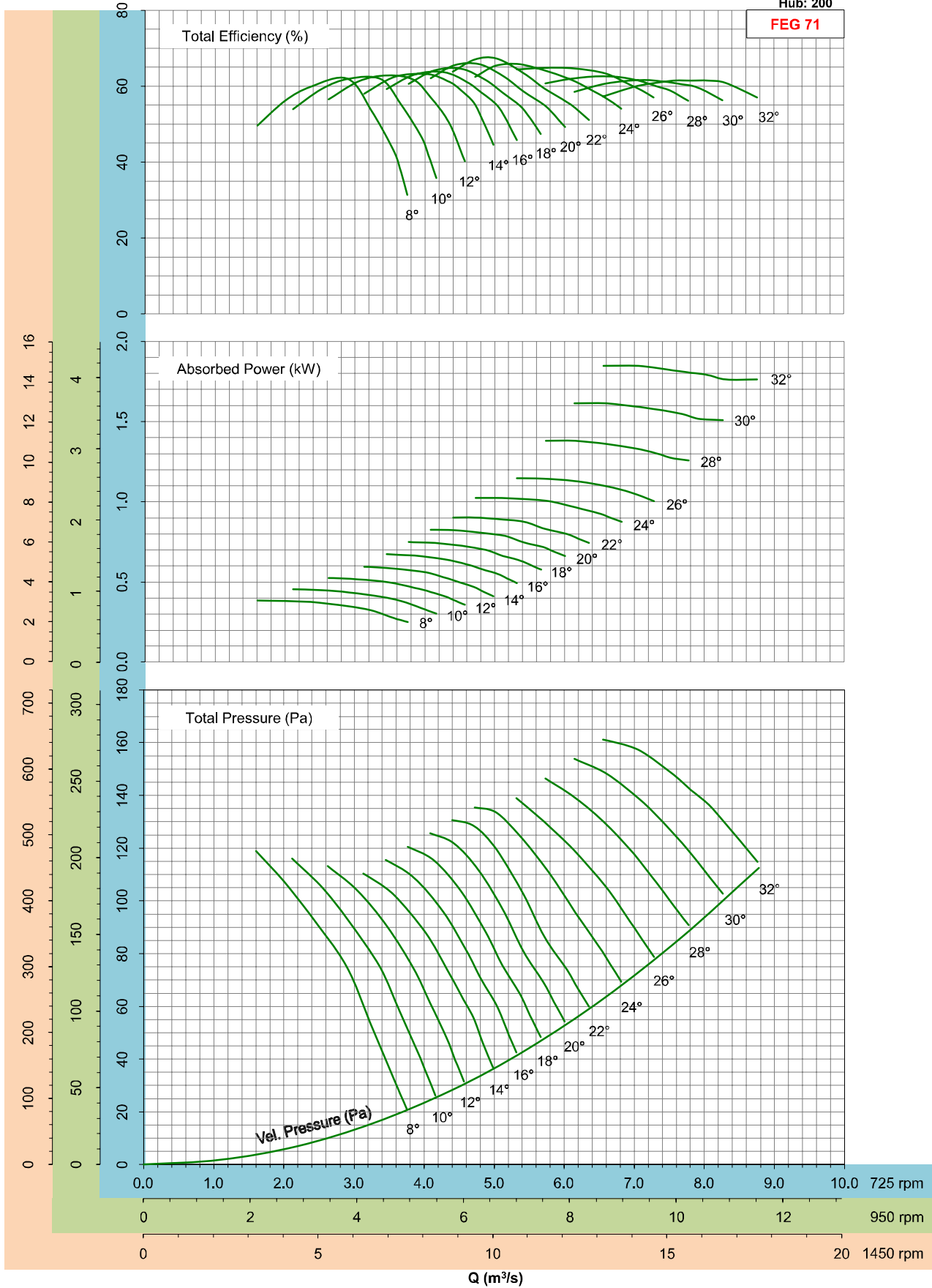

- Performance certified is for installation type D - ducted inlet, ducted outlet. Performance ratings do not include the effects of appurtenances (accessories).

TDA1000/14AA/6-12 50Hz



$\rho=1.2\text{kg/m}^3$
Hub: 280

FEG 75

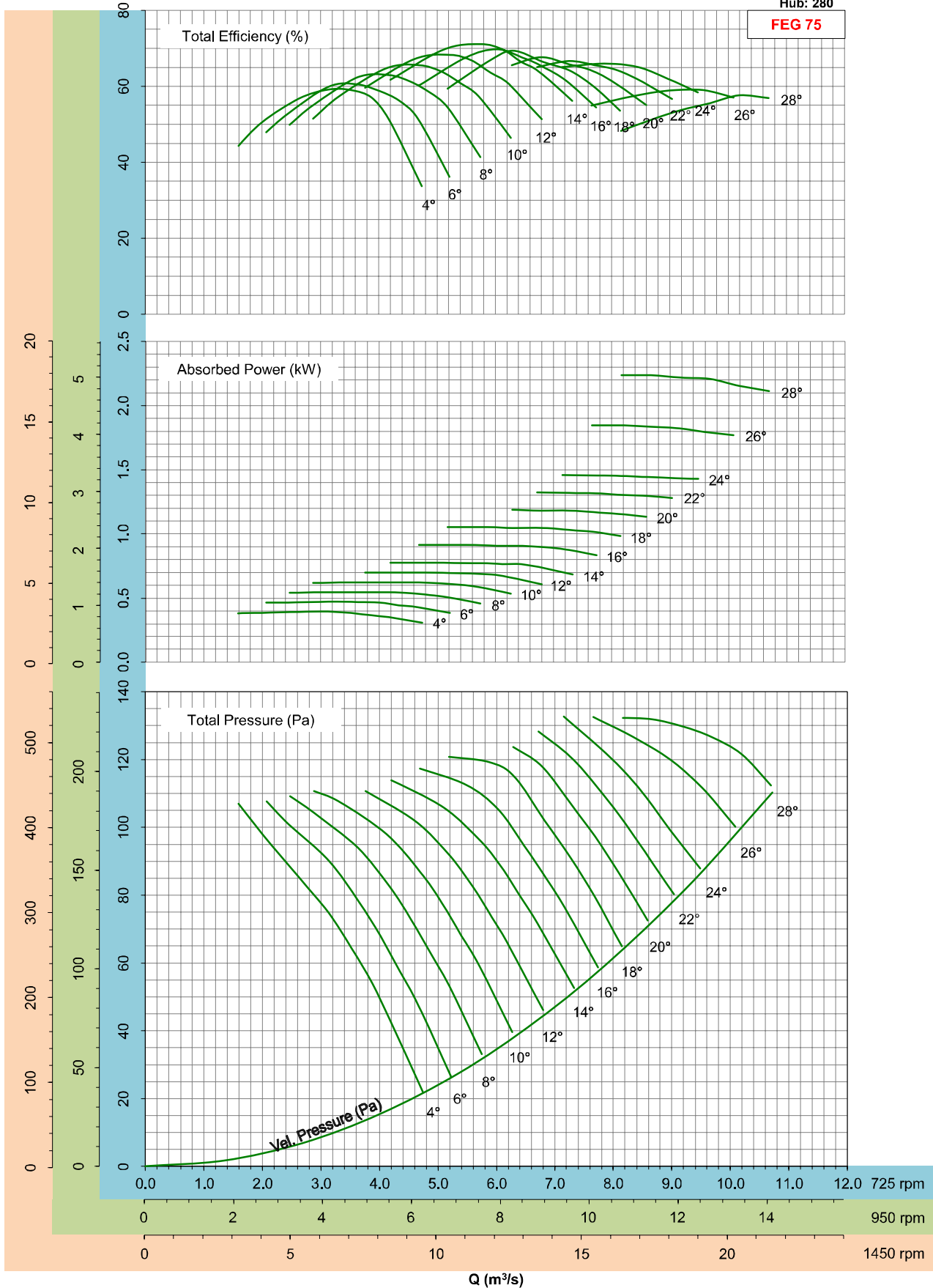

- Performance certified is for installation type D - ducted inlet, ducted outlet. Performance ratings do not include the effects of appurtenances (accessories).

TDA1000/14AA/7-7 50Hz



$\rho=1.2\text{kg/m}^3$
Hub: 186

FEG 75

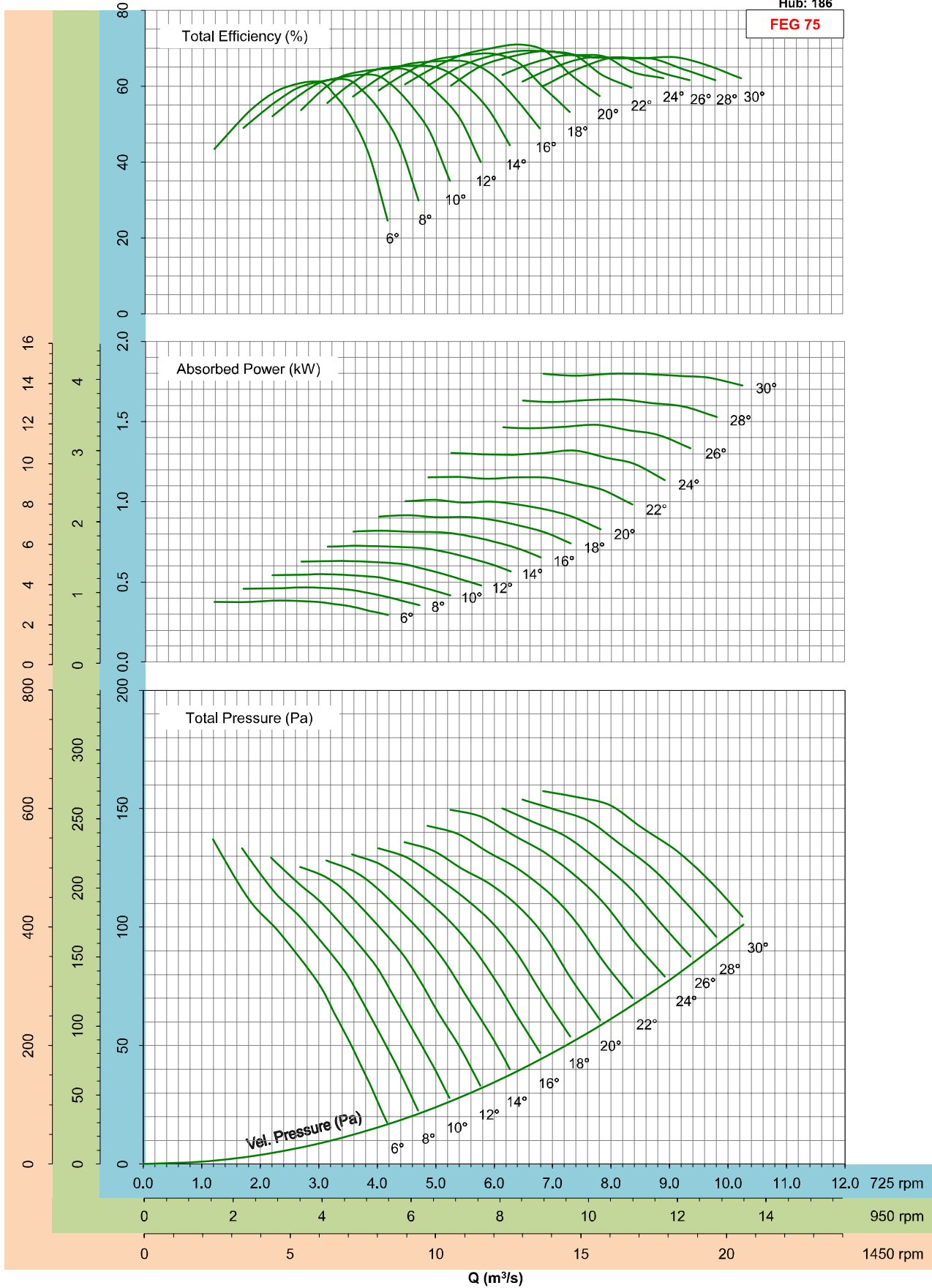

- Performance certified is for installation type D - ducted inlet, ducted outlet. Performance ratings do not include the effects of appurtenances (accessories).

TDA1000/14AA/9-9 50Hz



$\rho=1.2\text{kg/m}^3$
Hub: 200

FEG 75

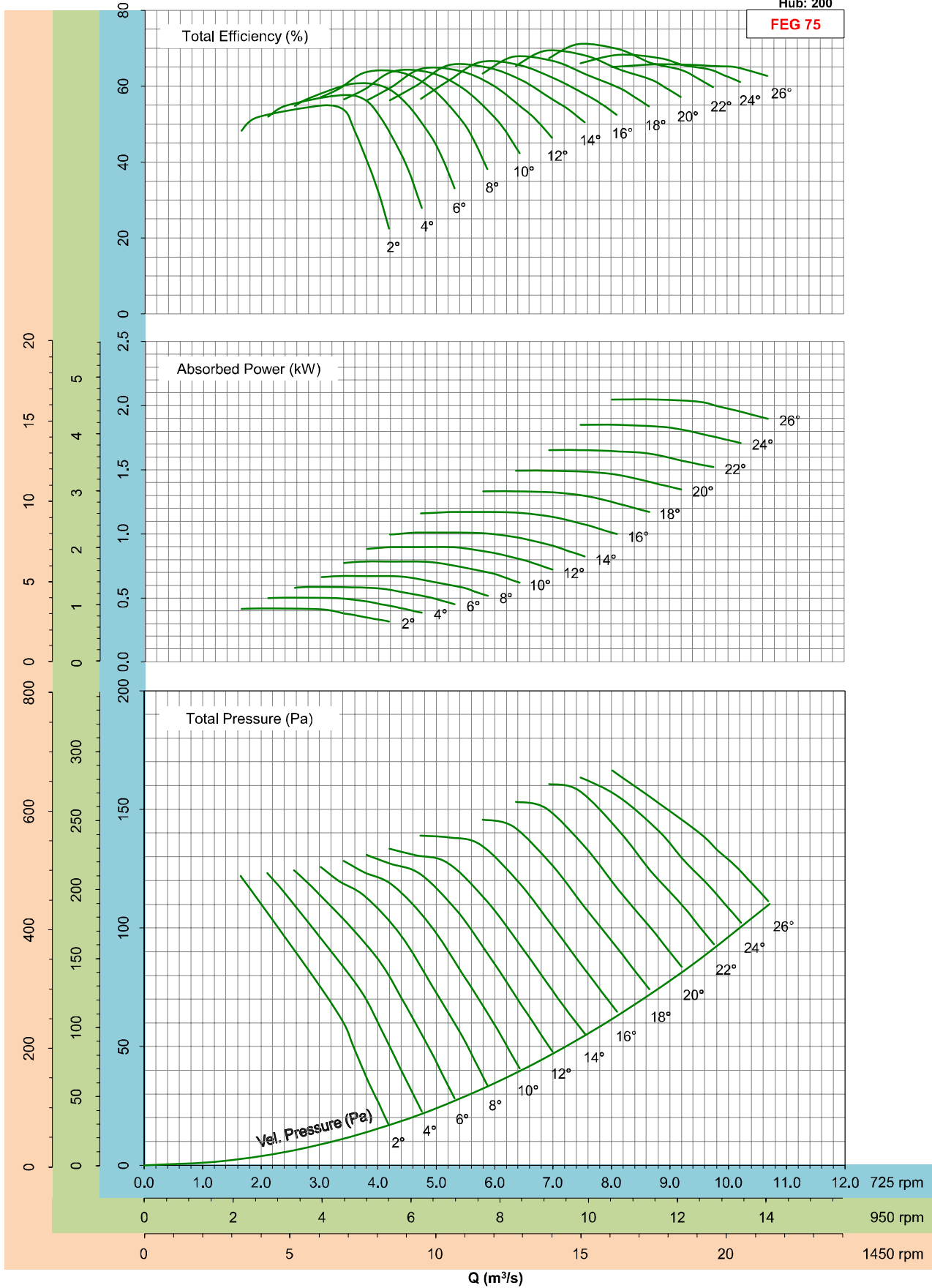

- Performance certified is for installation type D - ducted inlet, ducted outlet. Performance ratings do not include the effects of appurtenances (accessories).

TDA1000/20BH/4-4 50Hz



$\rho=1.2\text{kg/m}^3$
Hub: 280

FEG 71

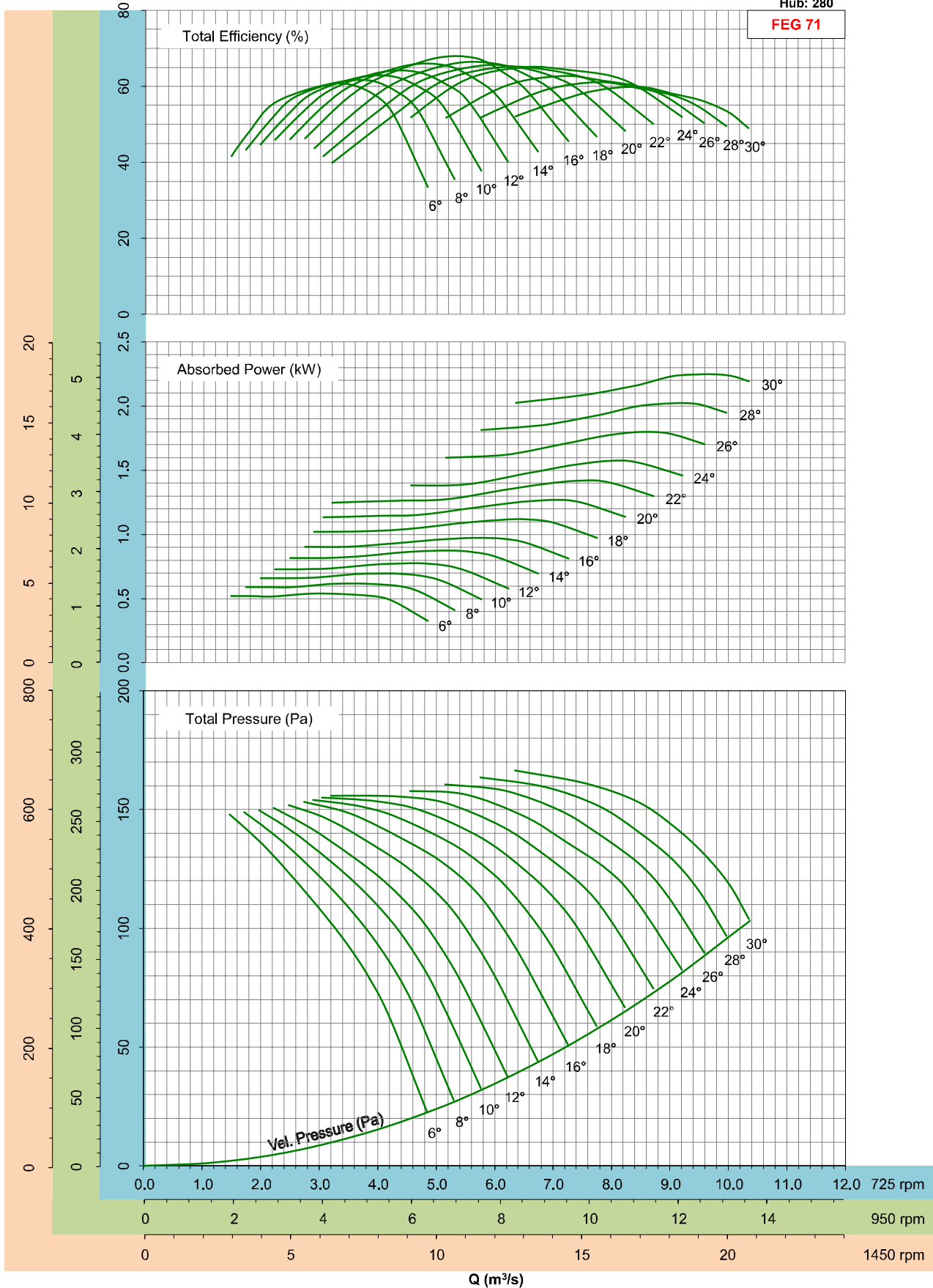

- Performance certified is for installation type D - ducted inlet, ducted outlet. Performance ratings do not include the effects of appurtenances (accessories).

TDA1000/20BH/6-6 50Hz



$\rho=1.2\text{kg/m}^3$
Hub: 280

FEG 71

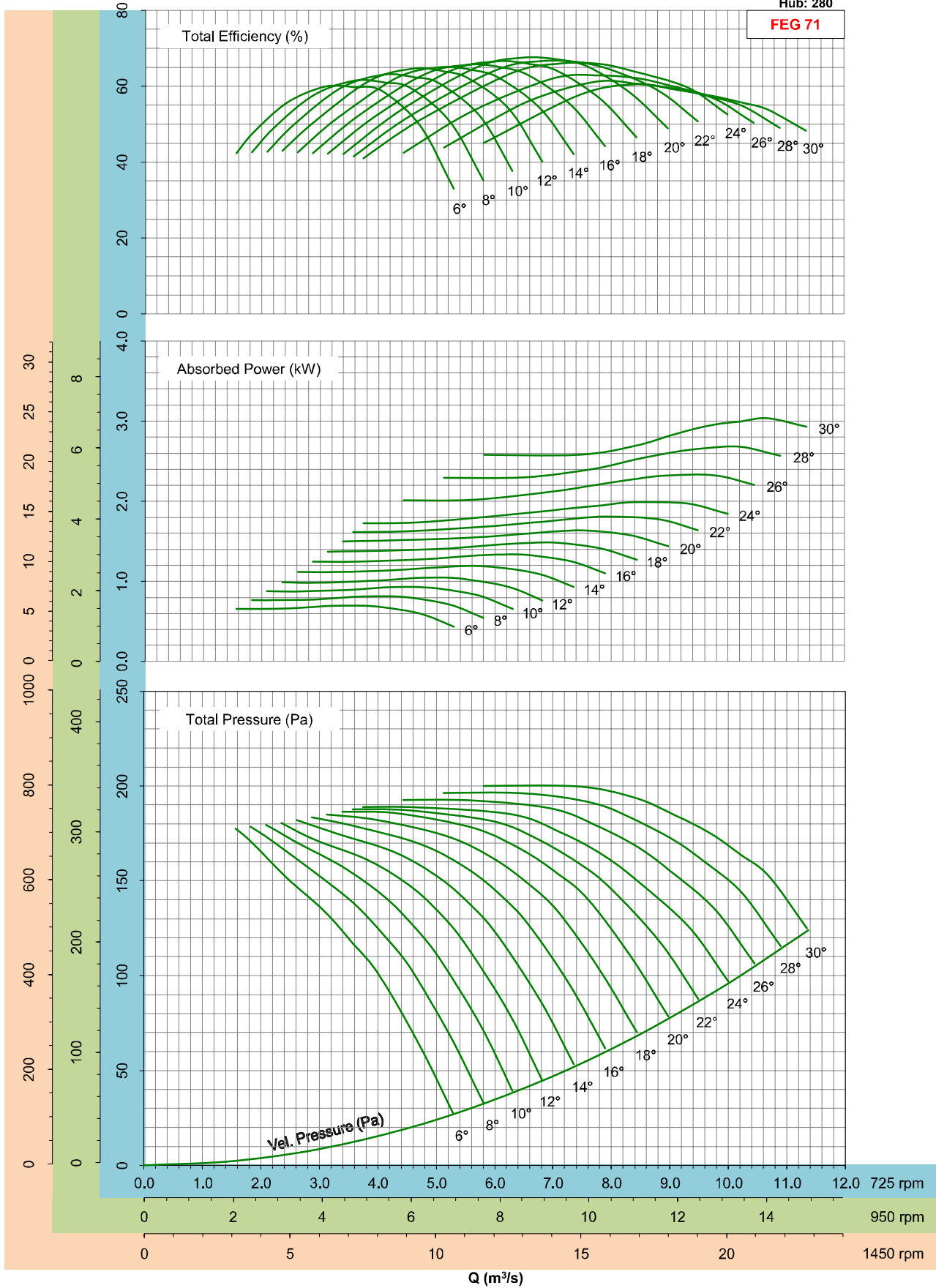

- Performance certified is for installation type D - ducted inlet, ducted outlet. Performance ratings do not include the effects of appurtenances (accessories).

TDA1000/20BH/8-8 50Hz



$\rho=1.2\text{kg/m}^3$
Hub: 280

FEG 71

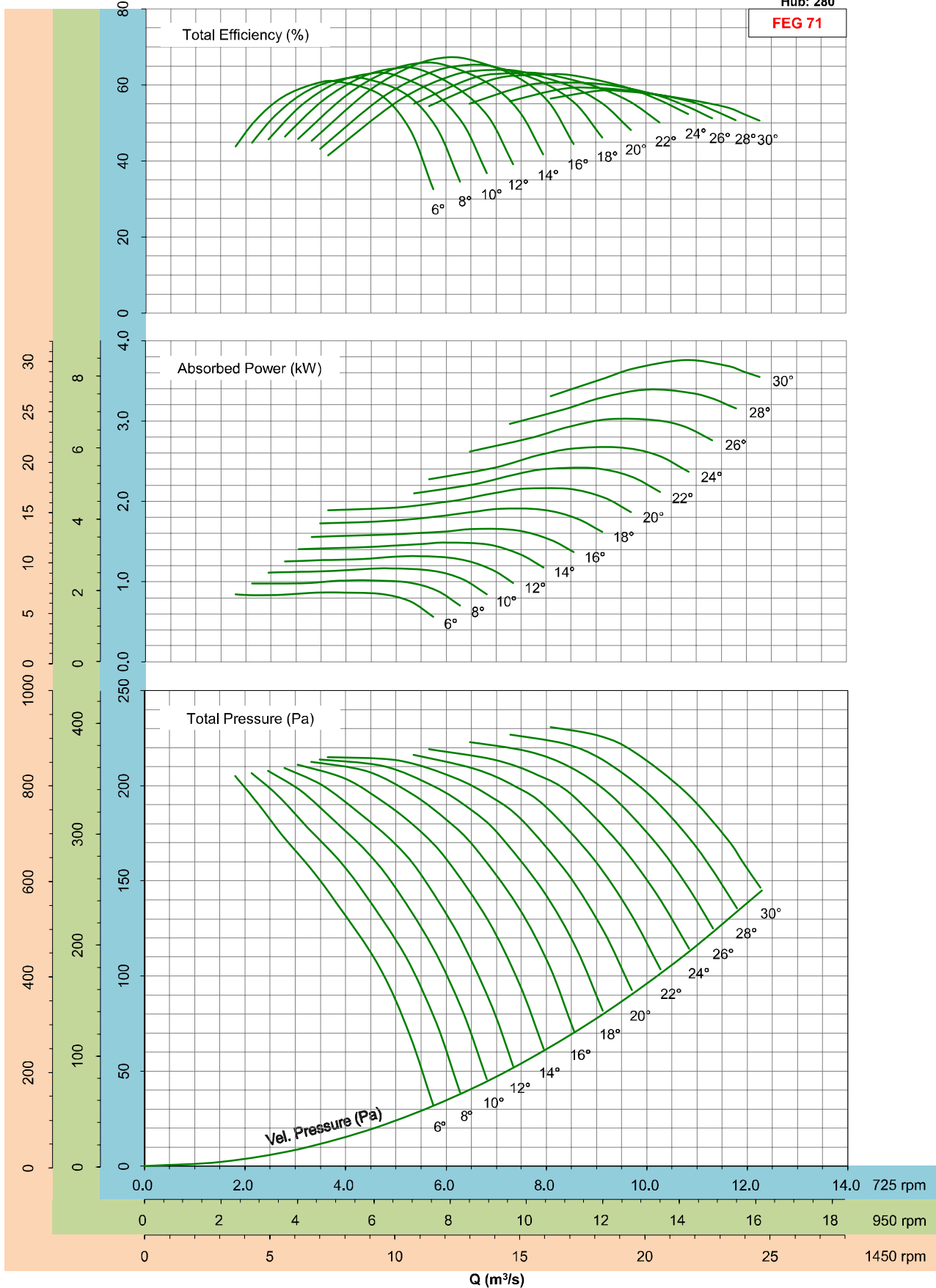

- Performance certified is for installation type D - ducted inlet, ducted outlet. Performance ratings do not include the effects of appurtenances (accessories).

TDA1120/14AA/6-12 50Hz



$\rho=1.2\text{kg/m}^3$
Hub: 280

FEG 75

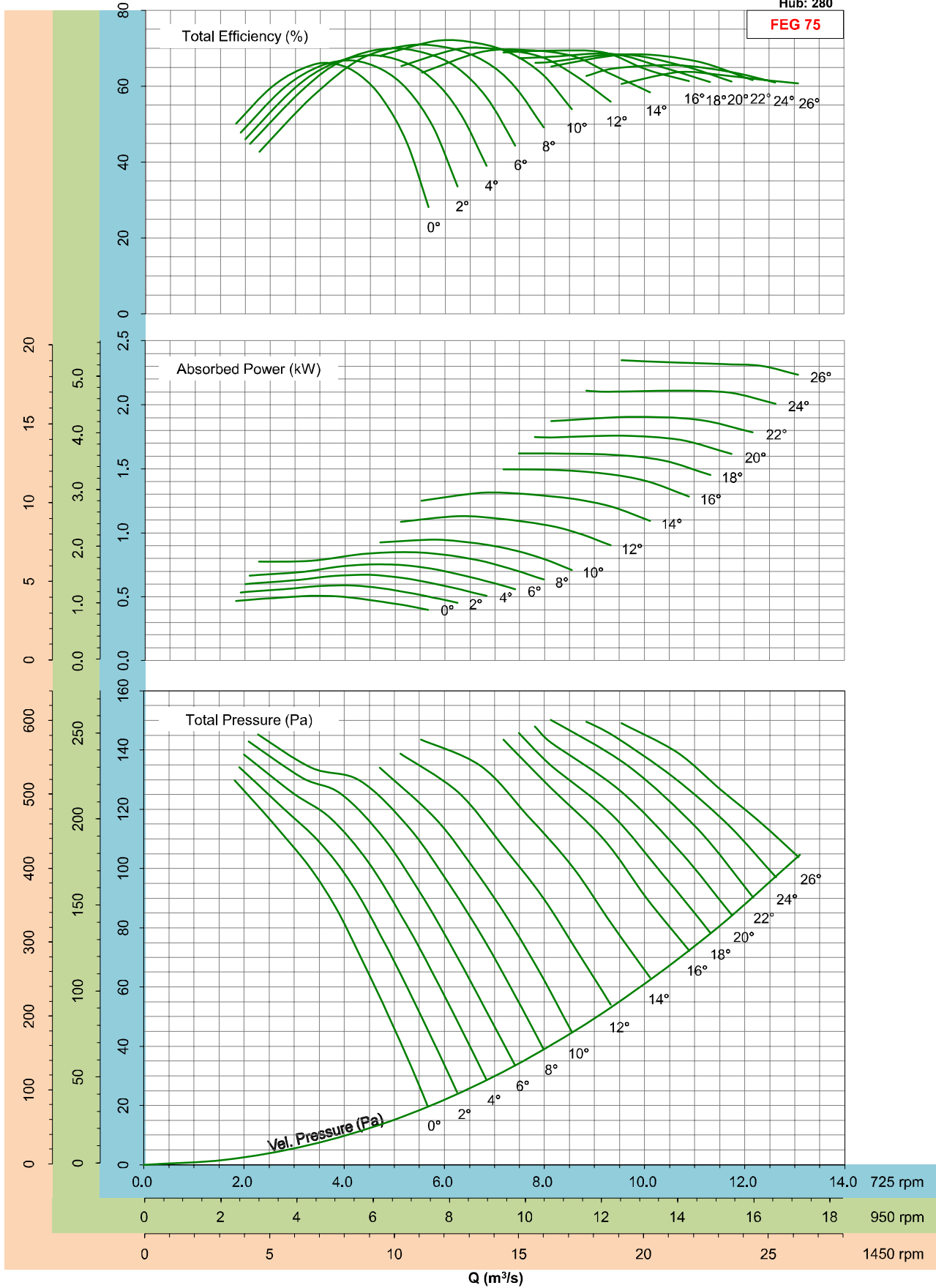

- Performance certified is for installation type D - ducted inlet, ducted outlet. Performance ratings do not include the effects of appurtenances (accessories).

TDA1120/14AA/8-8 50Hz



$\rho=1.2\text{kg/m}^3$
Hub: 266

FEG 75

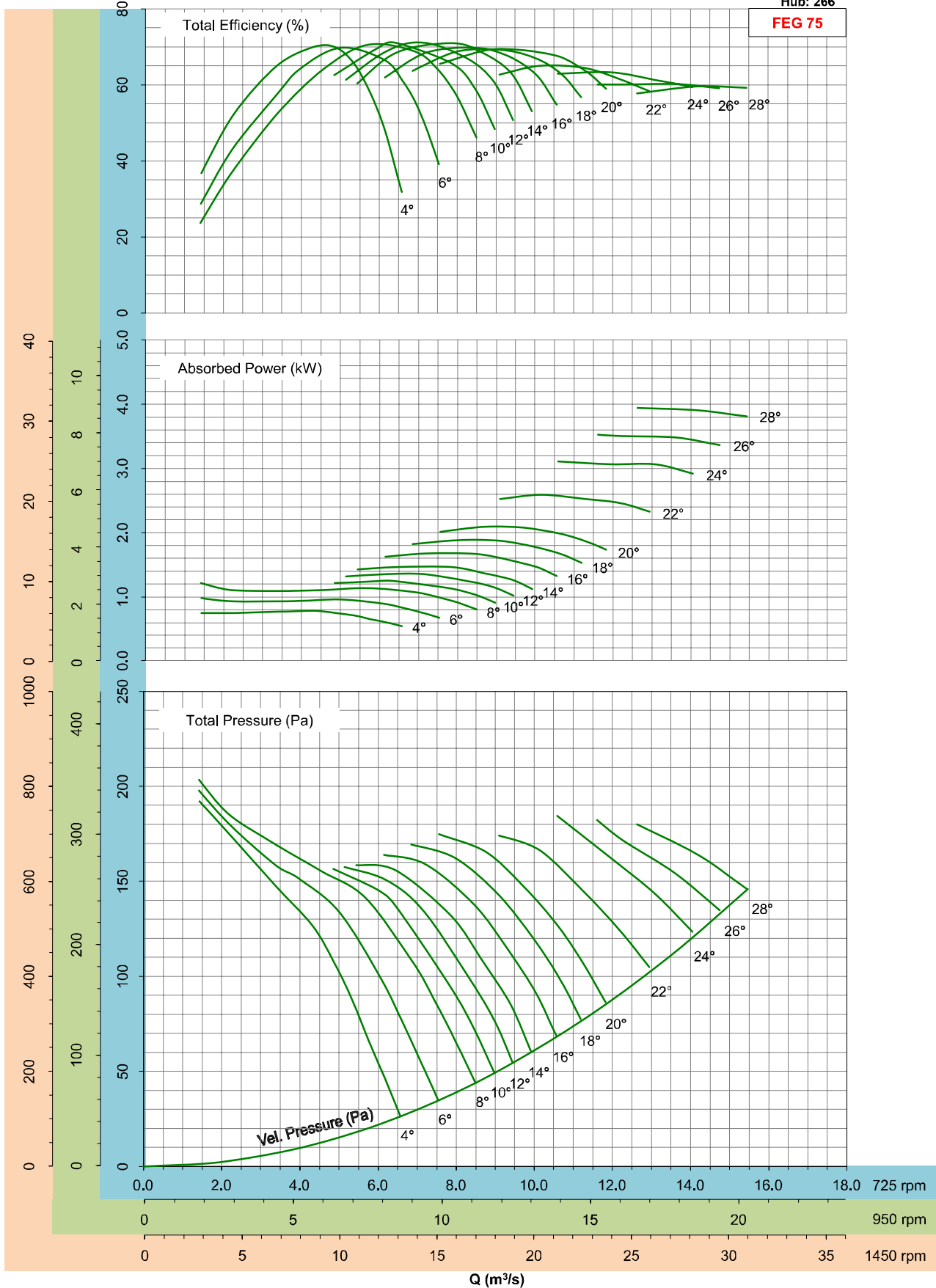

- Performance certified is for installation type D - ducted inlet, ducted outlet. Performance ratings do not include the effects of appurtenances (accessories).

TDA1120/18BI/4-4 50Hz



$\rho=1.2\text{kg/m}^3$
Hub: 315

FEG 71

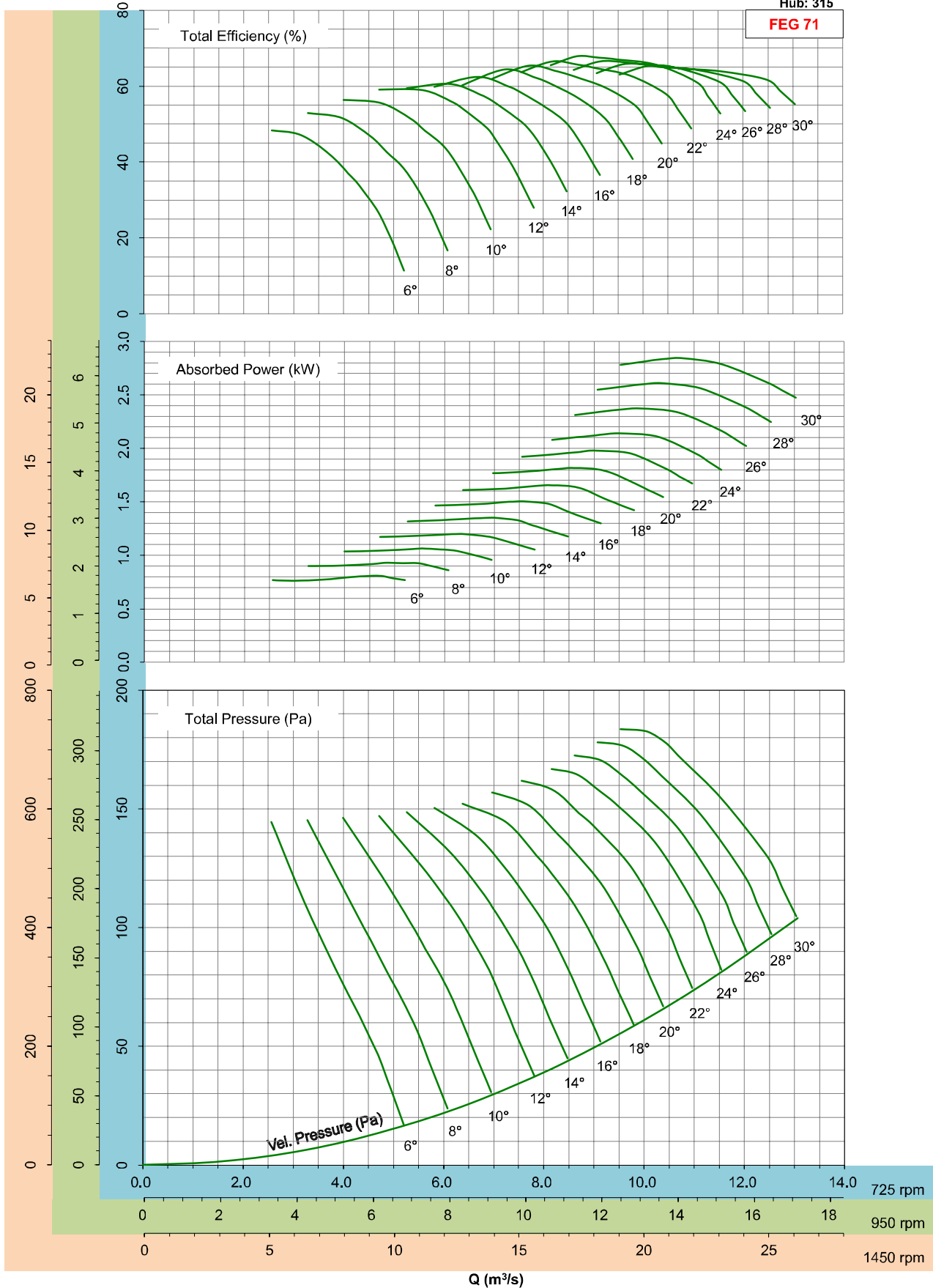

- Performance certified is for installation type D - ducted inlet, ducted outlet. Performance ratings do not include the effects of appurtenances (accessories).

TDA1120/18BI/6-6 50Hz



$\rho=1.2\text{kg/m}^3$
Hub: 315

FEG 71

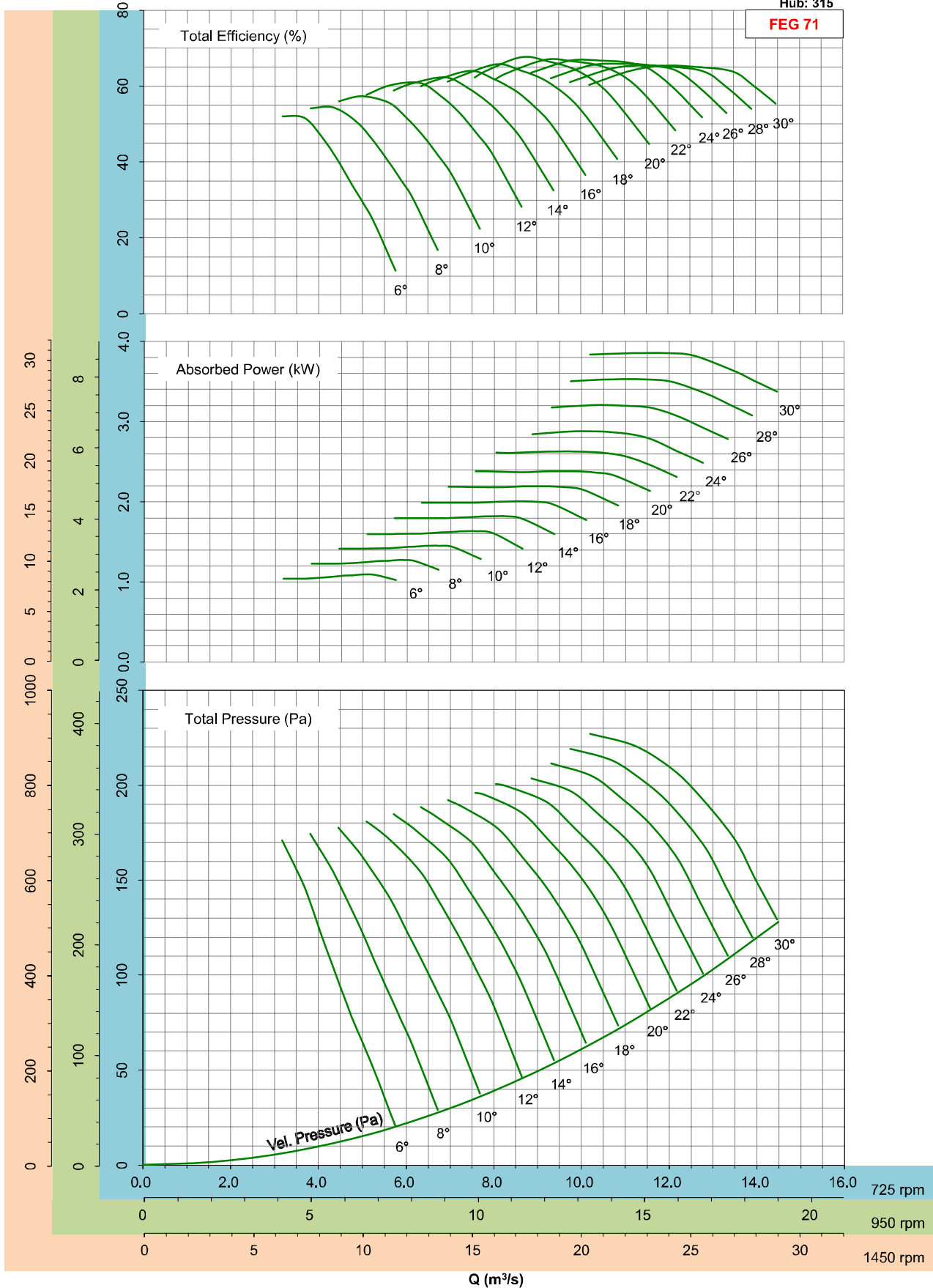

- Performance certified is for installation type D - ducted inlet, ducted outlet. Performance ratings do not include the effects of appurtenances (accessories).

TDA1120/18BI/8-8 50Hz



$\rho=1.2\text{kg/m}^3$
Hub: 315

FEG 71

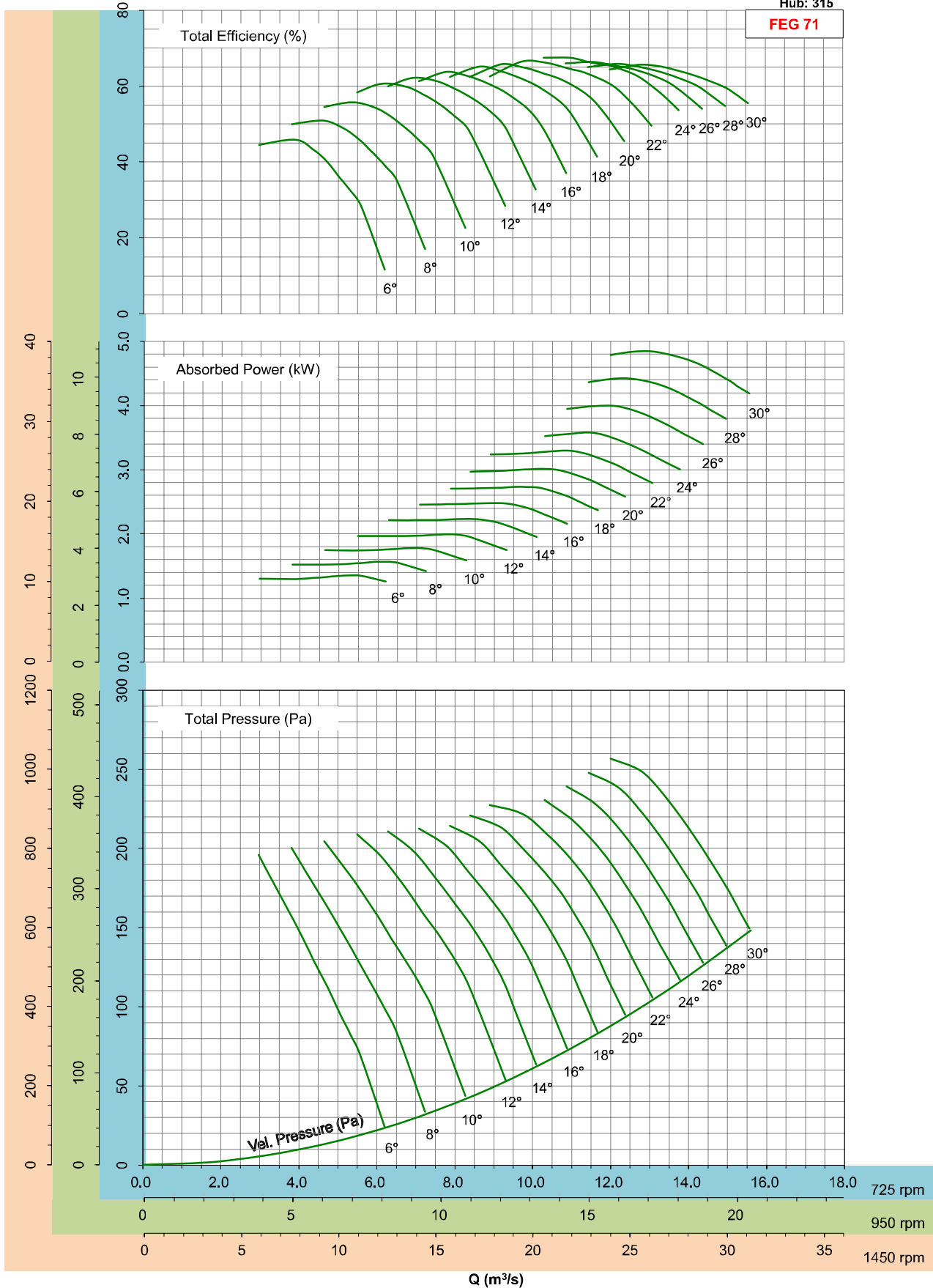

- Performance certified is for installation type D - ducted inlet, ducted outlet. Performance ratings do not include the effects of appurtenances (accessories).

TDA1120/20BI/4-4 50Hz



$\rho=1.2\text{kg/m}^3$
Hub: 315

FEG 71

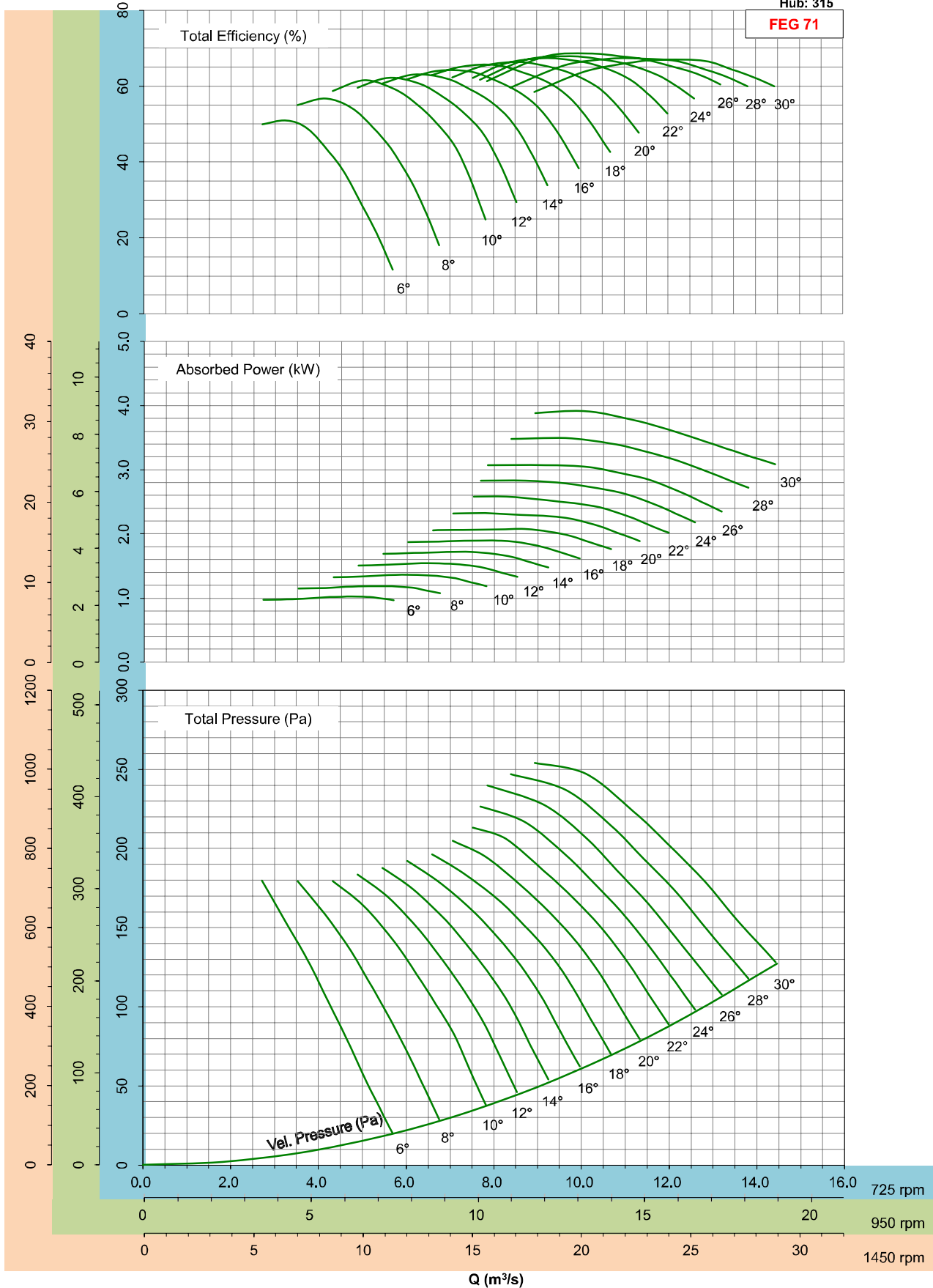

- Performance certified is for installation type D - ducted inlet, ducted outlet. Performance ratings do not include the effects of appurtenances (accessories).

TDA1120/20BI/6-6 50Hz



$\rho=1.2\text{kg/m}^3$
Hub: 315

FEG 71

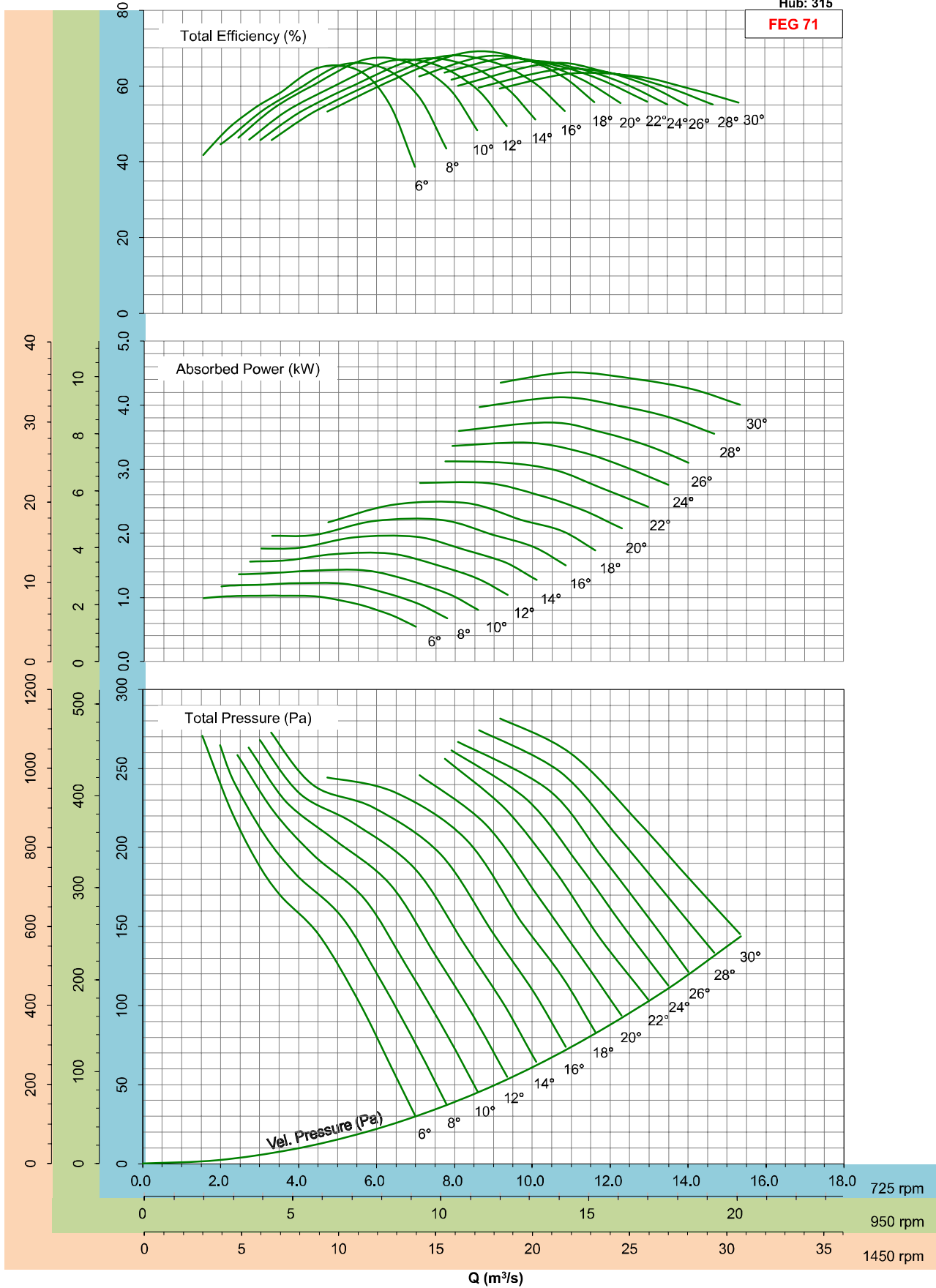

- Performance certified is for installation type D - ducted inlet, ducted outlet. Performance ratings do not include the effects of appurtenances (accessories).

TDA1120/20BI/8-8 50Hz



$\rho=1.2\text{kg/m}^3$
Hub: 315

FEG 71

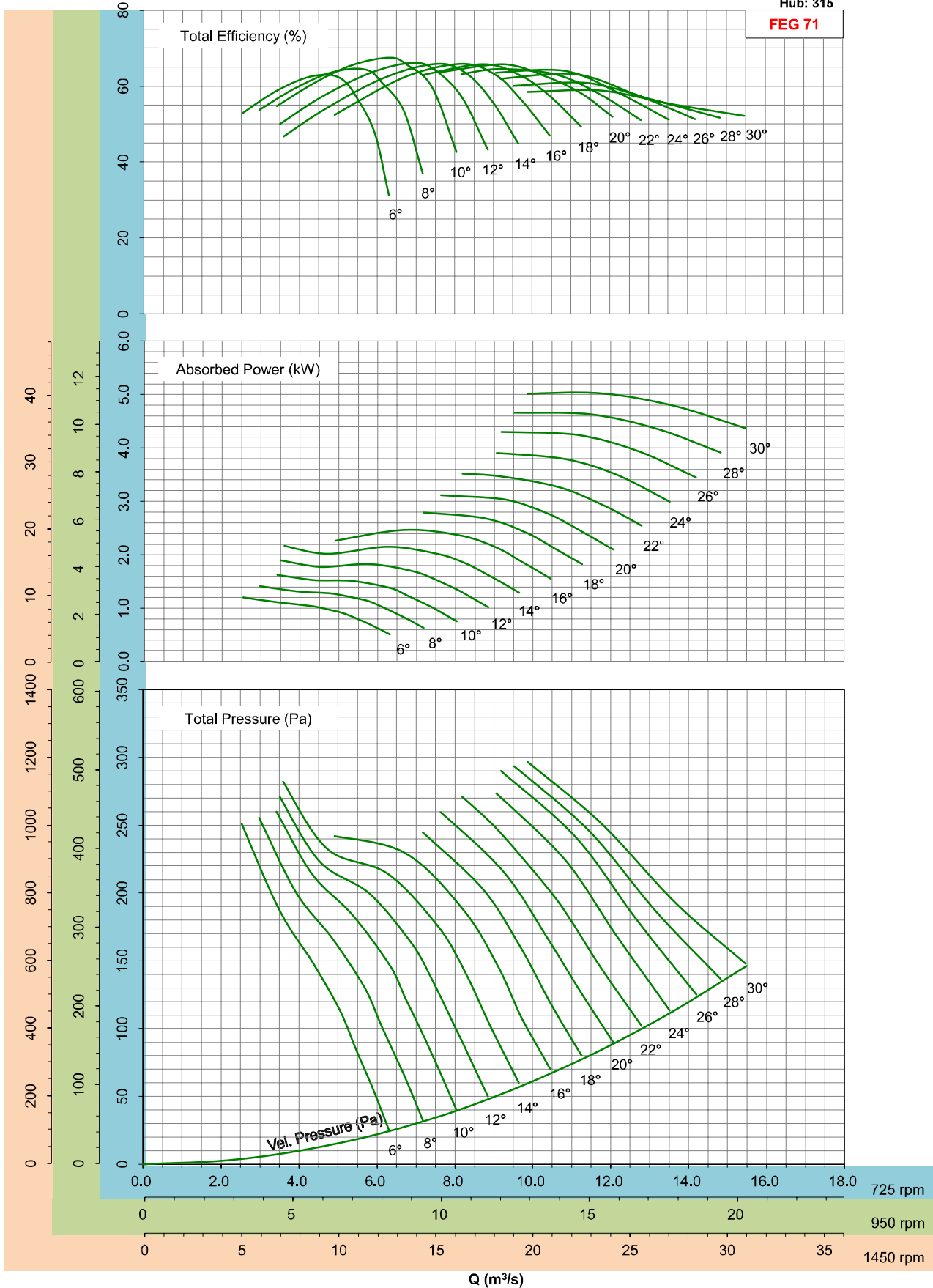

- Performance certified is for installation type D - ducted inlet, ducted outlet. Performance ratings do not include the effects of appurtenances (accessories).

TDA1250/20BJ/4-4 50Hz



$\rho=1.2\text{kg/m}^3$
Hub: 353

FEG 71

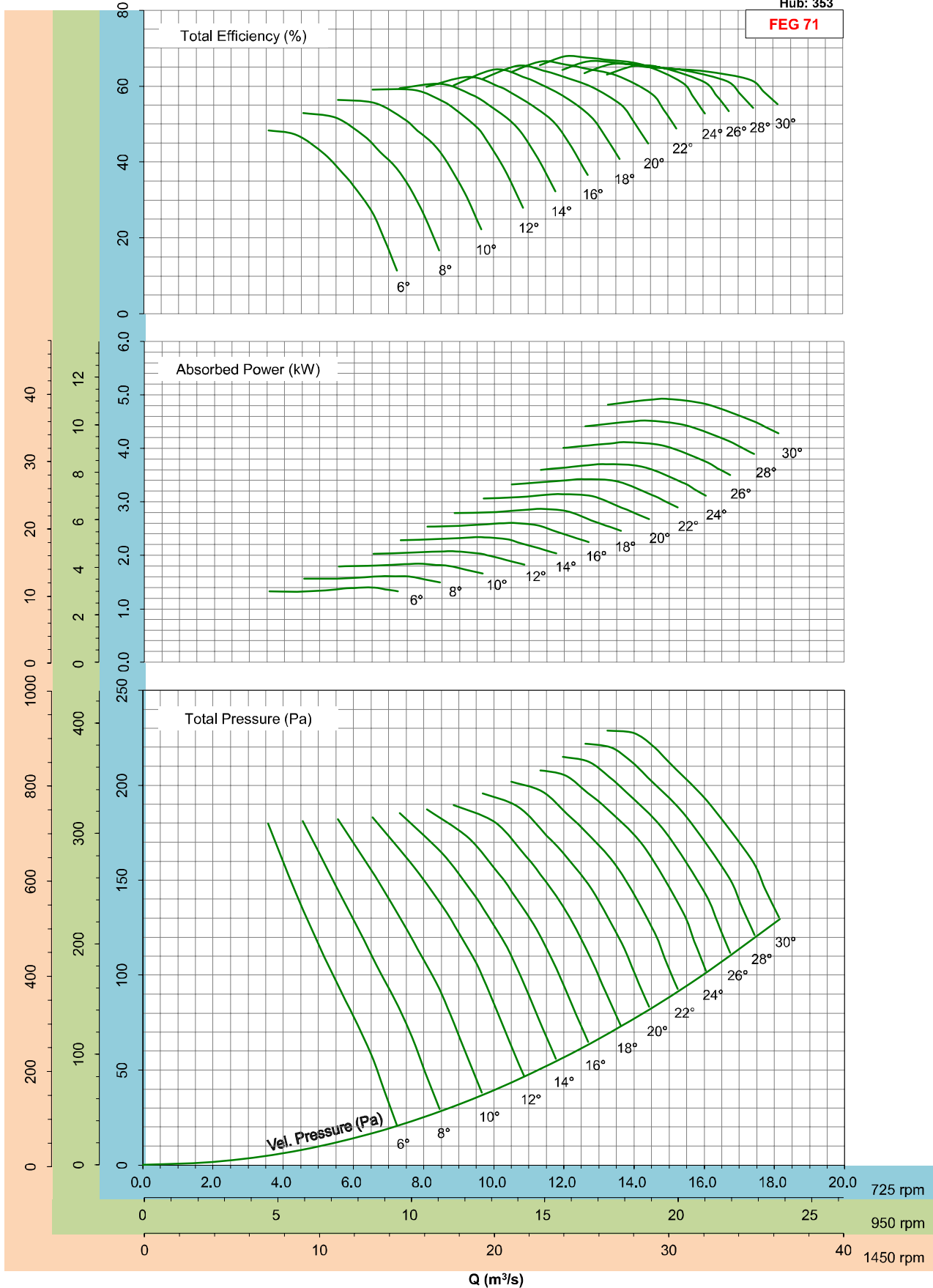

- Performance certified is for installation type D - ducted inlet, ducted outlet. Performance ratings do not include the effects of appurtenances (accessories).

- Please consult the nearest Kruger office for fan selection at 1450rpm.

TDA1250/20BJ/6-6 50Hz



$\rho=1.2\text{kg/m}^3$
Hub: 353

FEG 71

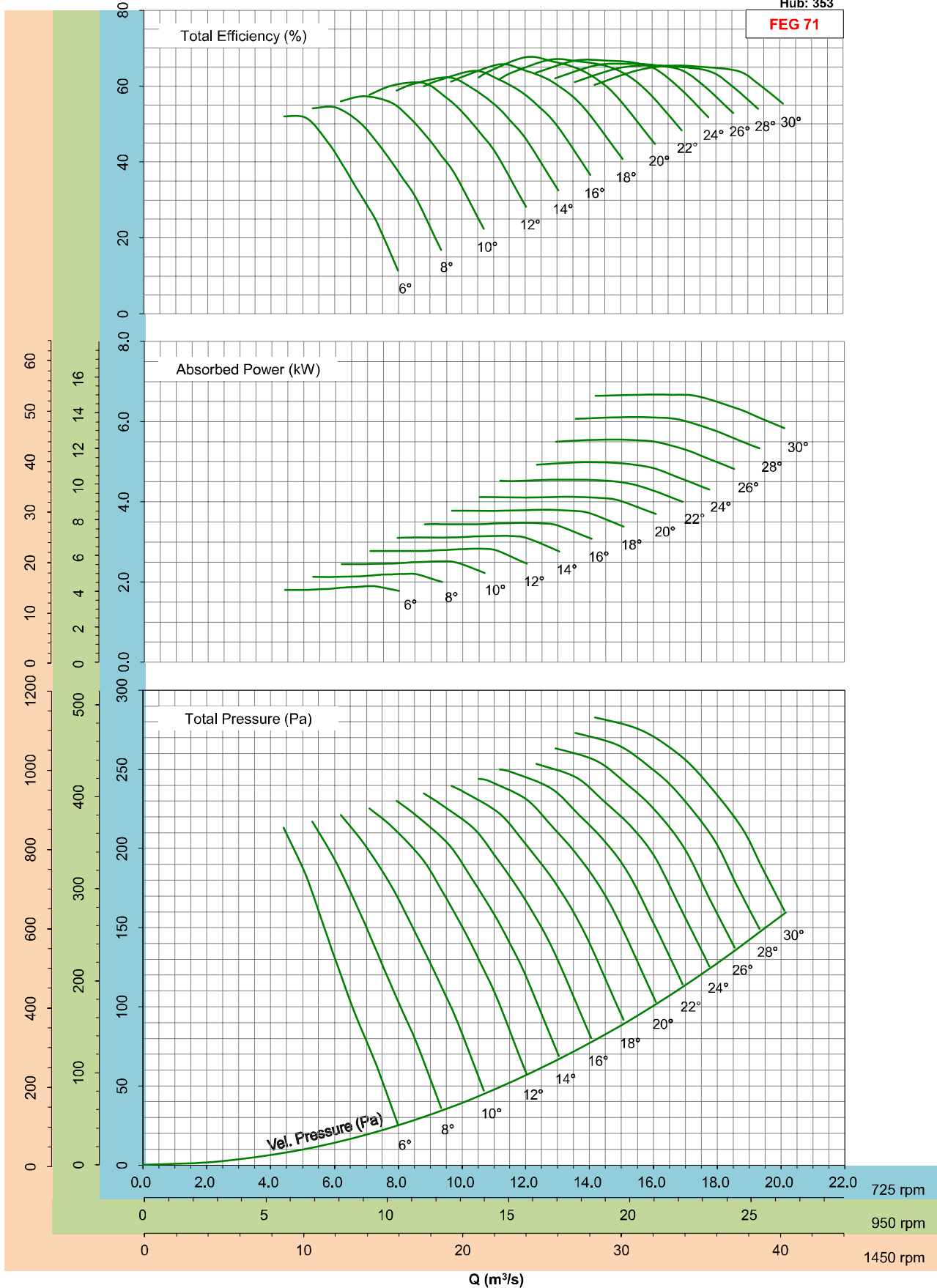

- Performance certified is for installation type D - ducted inlet, ducted outlet. Performance ratings do not include the effects of appurtenances (accessories).

- Please consult the nearest Kruger office for fan selection at 1450rpm.

TDA1250/20BJ/8-8 50Hz



$\rho=1.2\text{kg/m}^3$
Hub: 353

FEG 71

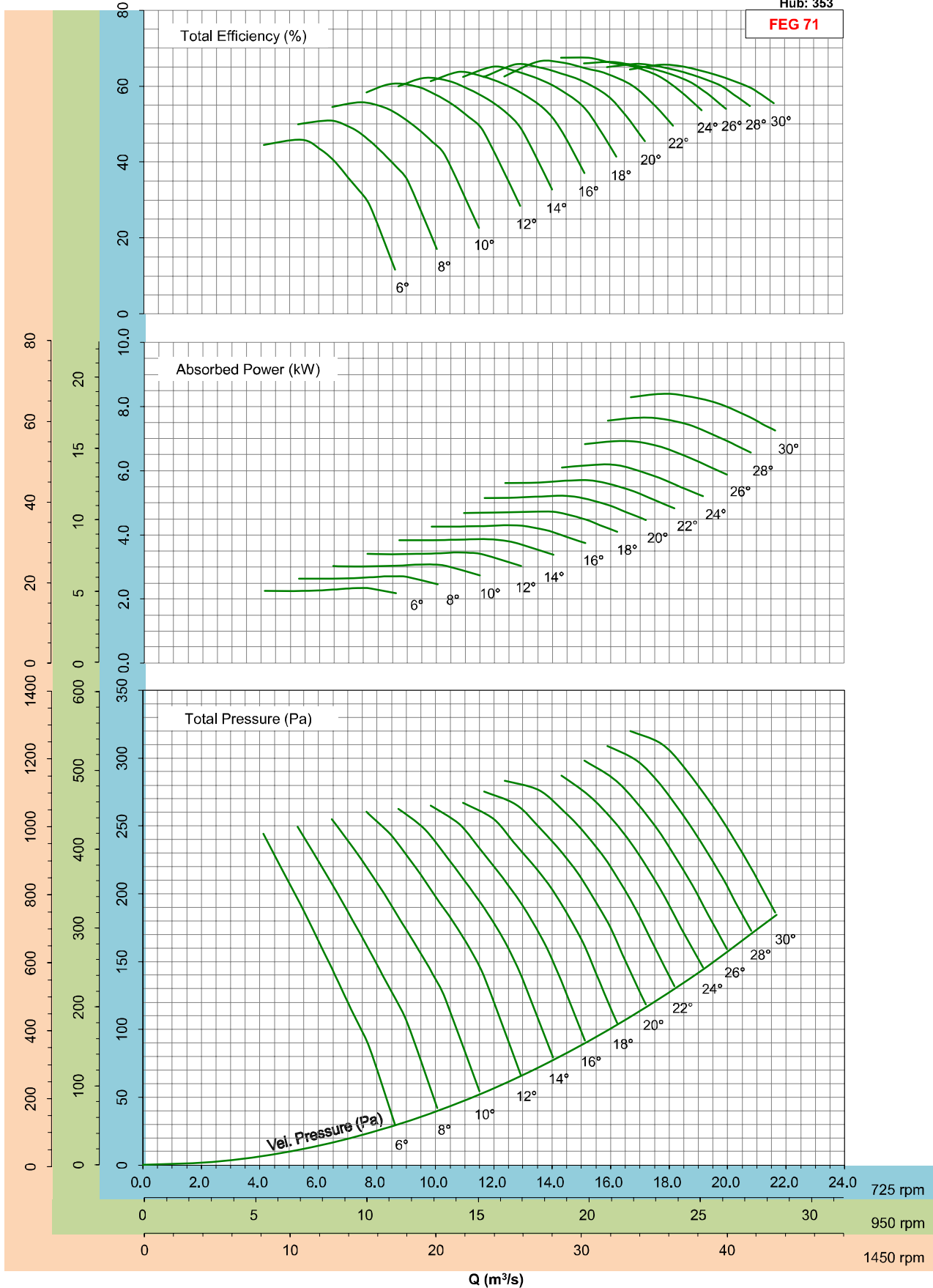

- Performance certified is for installation type D - ducted inlet, ducted outlet. Performance ratings do not include the effects of appurtenances (accessories).

- Please consult the nearest Kruger office for fan selection at 1450rpm.

TDA1250/25BJ/4-4 50Hz



$\rho=1.2\text{kg/m}^3$
Hub: 353

FEG 71

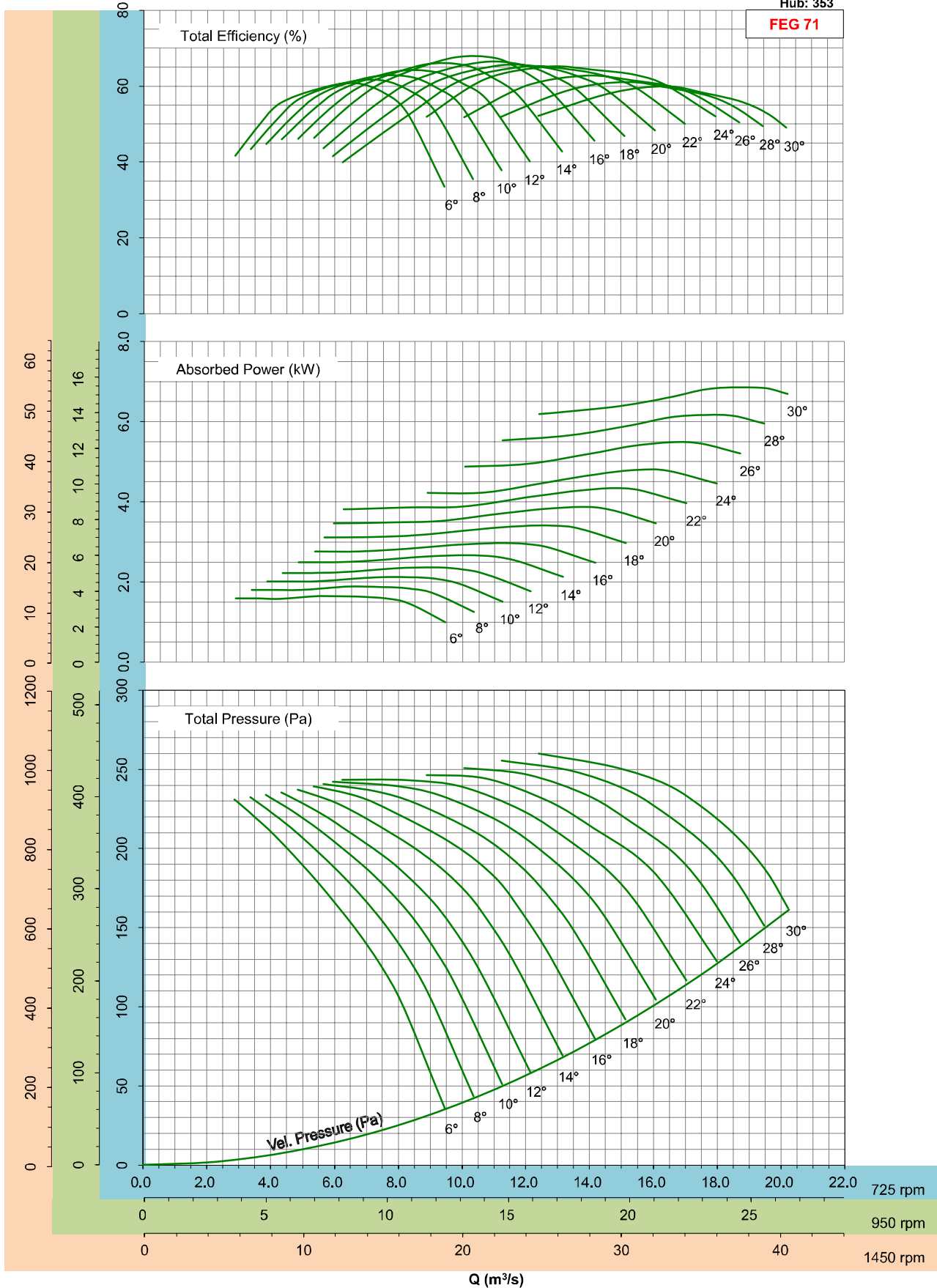

- Performance certified is for installation type D - ducted inlet, ducted outlet. Performance ratings do not include the effects of appurtenances (accessories).

- Please consult the nearest Kruger office for fan selection at 1450rpm.

TDA1250/25BJ/6-6 50Hz



$\rho=1.2\text{kg/m}^3$
Hub: 353

FEG 71

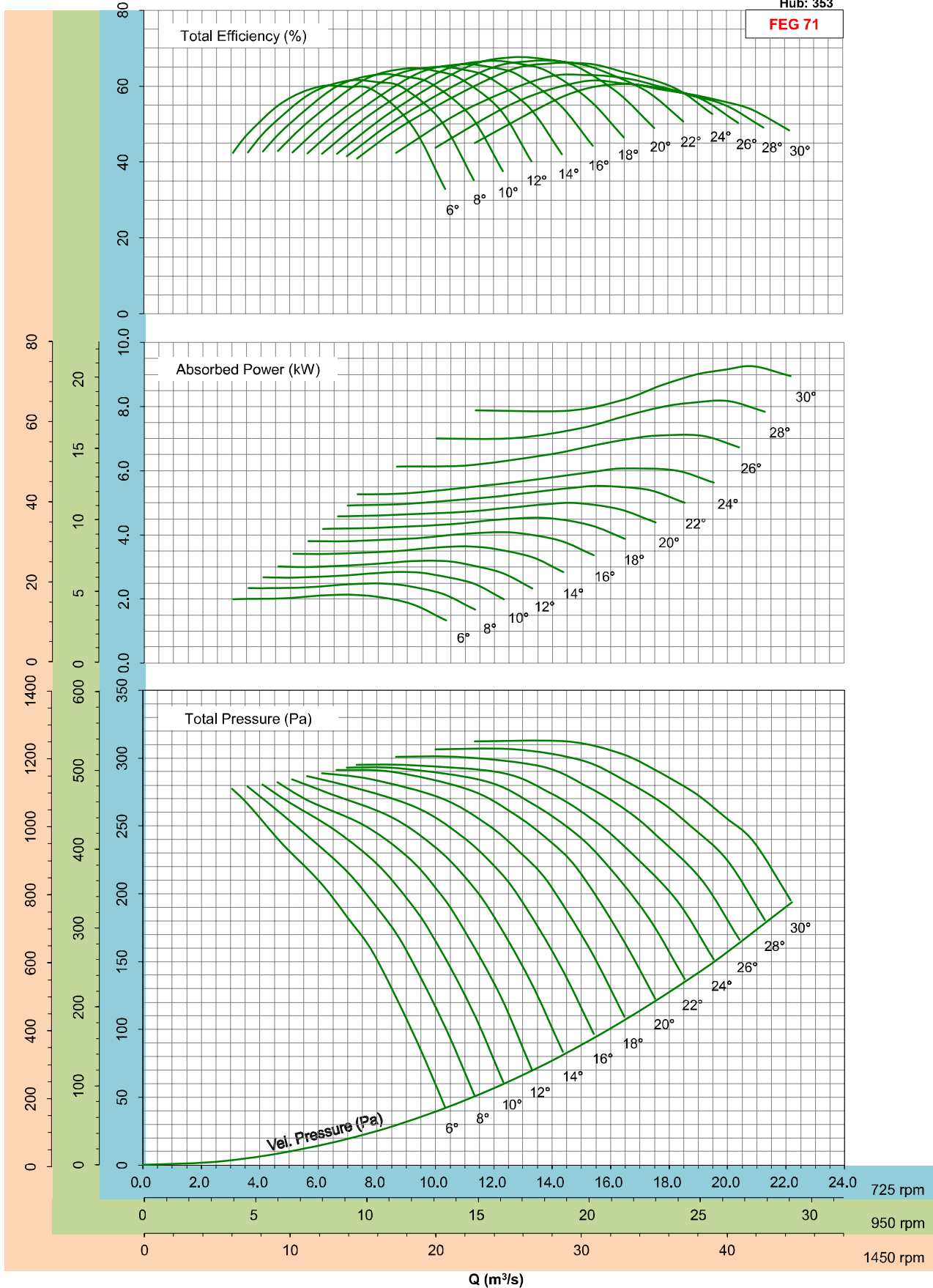

- Performance certified is for installation type D - ducted inlet, ducted outlet. Performance ratings do not include the effects of appurtenances (accessories).

- Please consult the nearest Kruger office for fan selection at 1450rpm.

TDA1250/25BJ/8-8 50Hz



$\rho=1.2\text{kg/m}^3$
Hub: 353

FEG 71

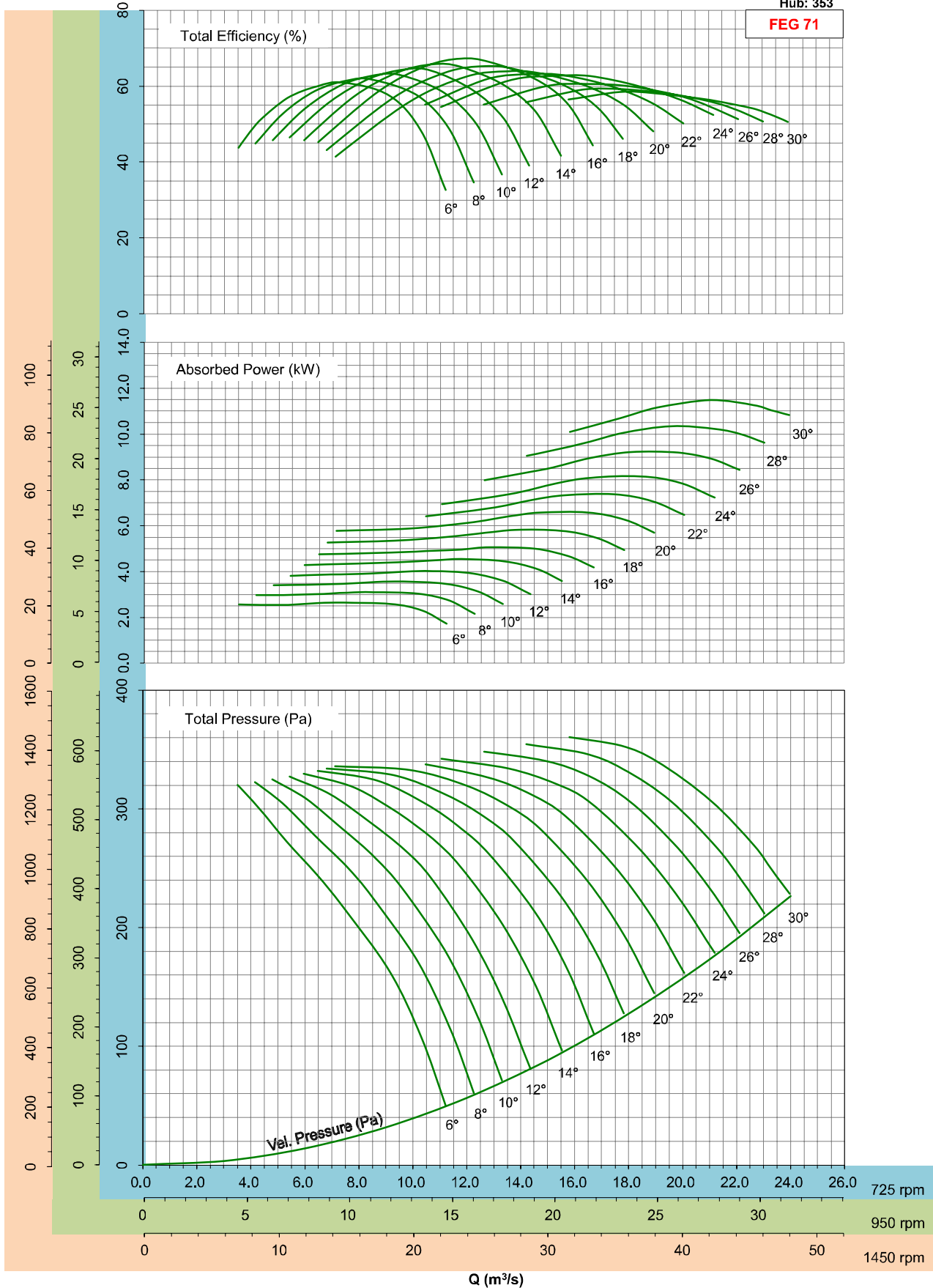

- Performance certified is for installation type D - ducted inlet, ducted outlet. Performance ratings do not include the effects of appurtenances (accessories).

- Please consult the nearest Kruger office for fan selection at 1450rpm.

TDA1400/25BK/4-4 50Hz



$\rho=1.2\text{kg/m}^3$
Hub: 397

FEG 71

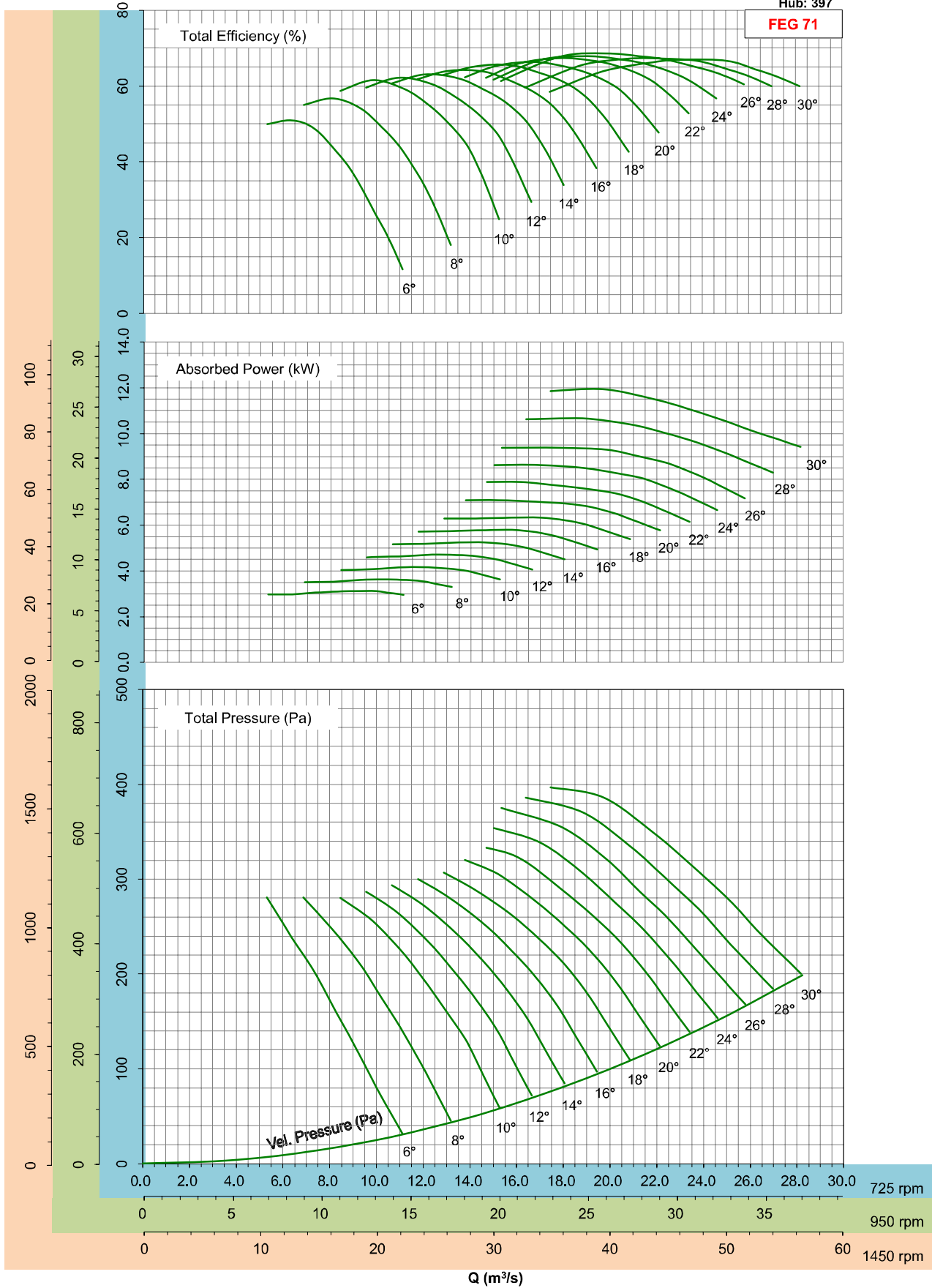

- Performance certified is for installation type D - ducted inlet, ducted outlet. Performance ratings do not include the effects of appurtenances (accessories).

- Please consult the nearest Kruger office for fan selection at 1450rpm.

TDA1400/25BK/6-6 50Hz



$\rho=1.2\text{kg/m}^3$
Hub: 397

FEG 71

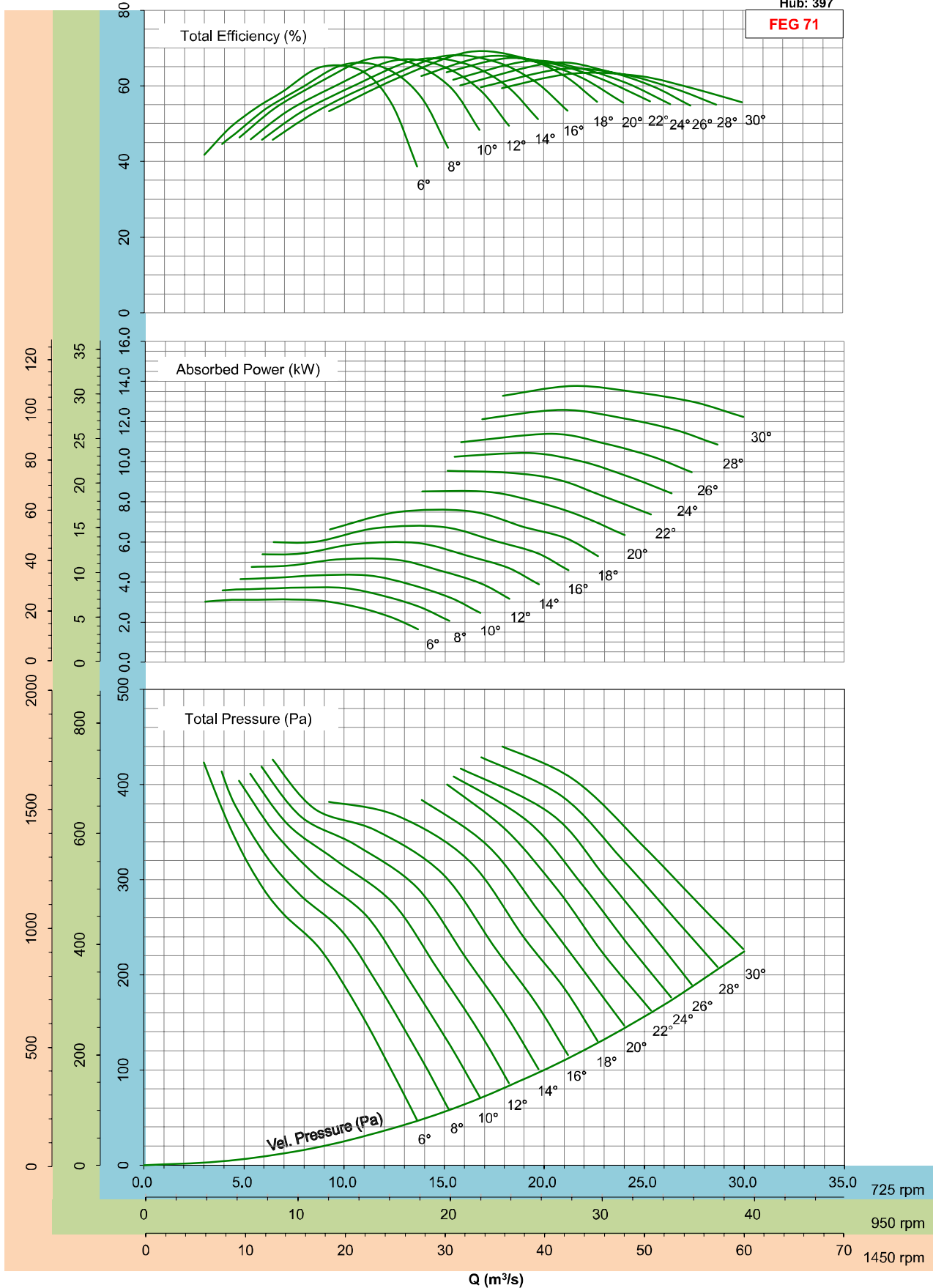

- Performance certified is for installation type D - ducted inlet, ducted outlet. Performance ratings do not include the effects of appurtenances (accessories).

- Please consult the nearest Kruger office for fan selection at 1450rpm.

TDA1400/25BK/8-8 50Hz



$\rho=1.2\text{kg/m}^3$
Hub: 397

FEG 71

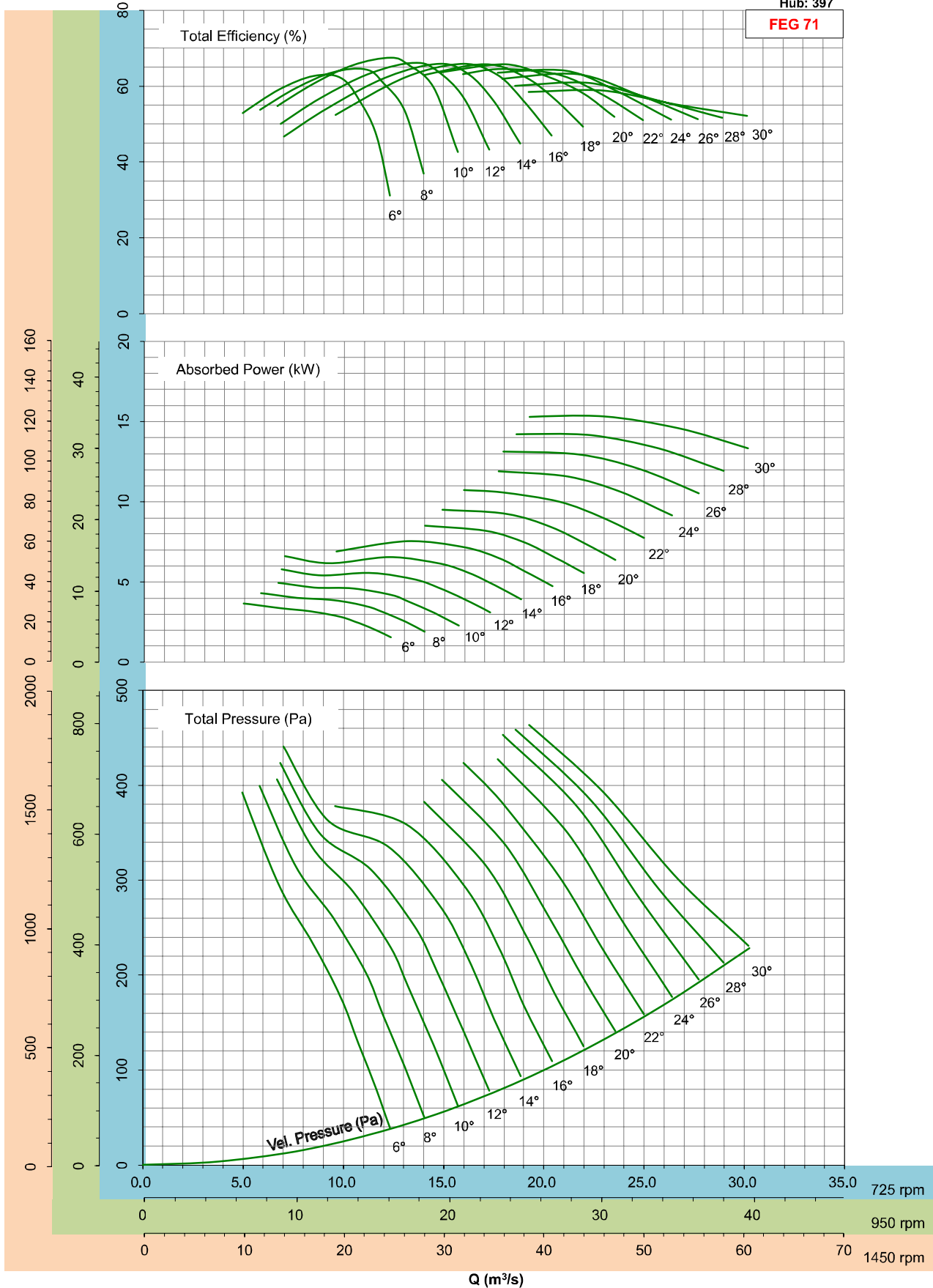

- Performance certified is for installation type D - ducted inlet, ducted outlet. Performance ratings do not include the effects of appurtenances (accessories).

- Please consult the nearest Kruger office for fan selection at 1450rpm.

TDA1600/25BL/4-4 50Hz



$\rho=1.2\text{kg/m}^3$
Hub: 450

FEG 71

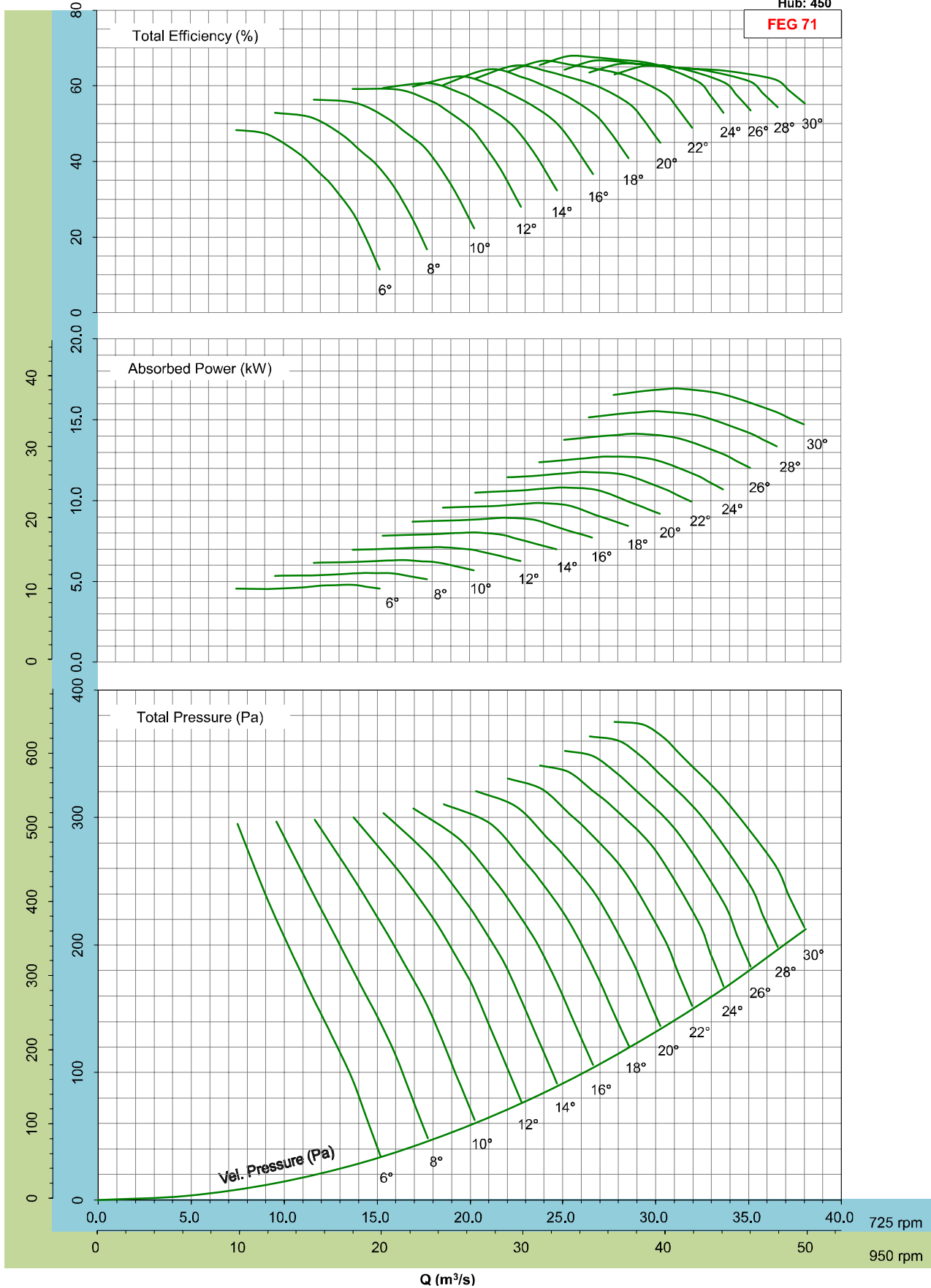

- Performance certified is for installation type D - ducted inlet, ducted outlet. Performance ratings do not include the effects of appurtenances (accessories).

TDA1600/25BL/6-6 50Hz



$\rho=1.2\text{kg/m}^3$
Hub: 450

FEG 71

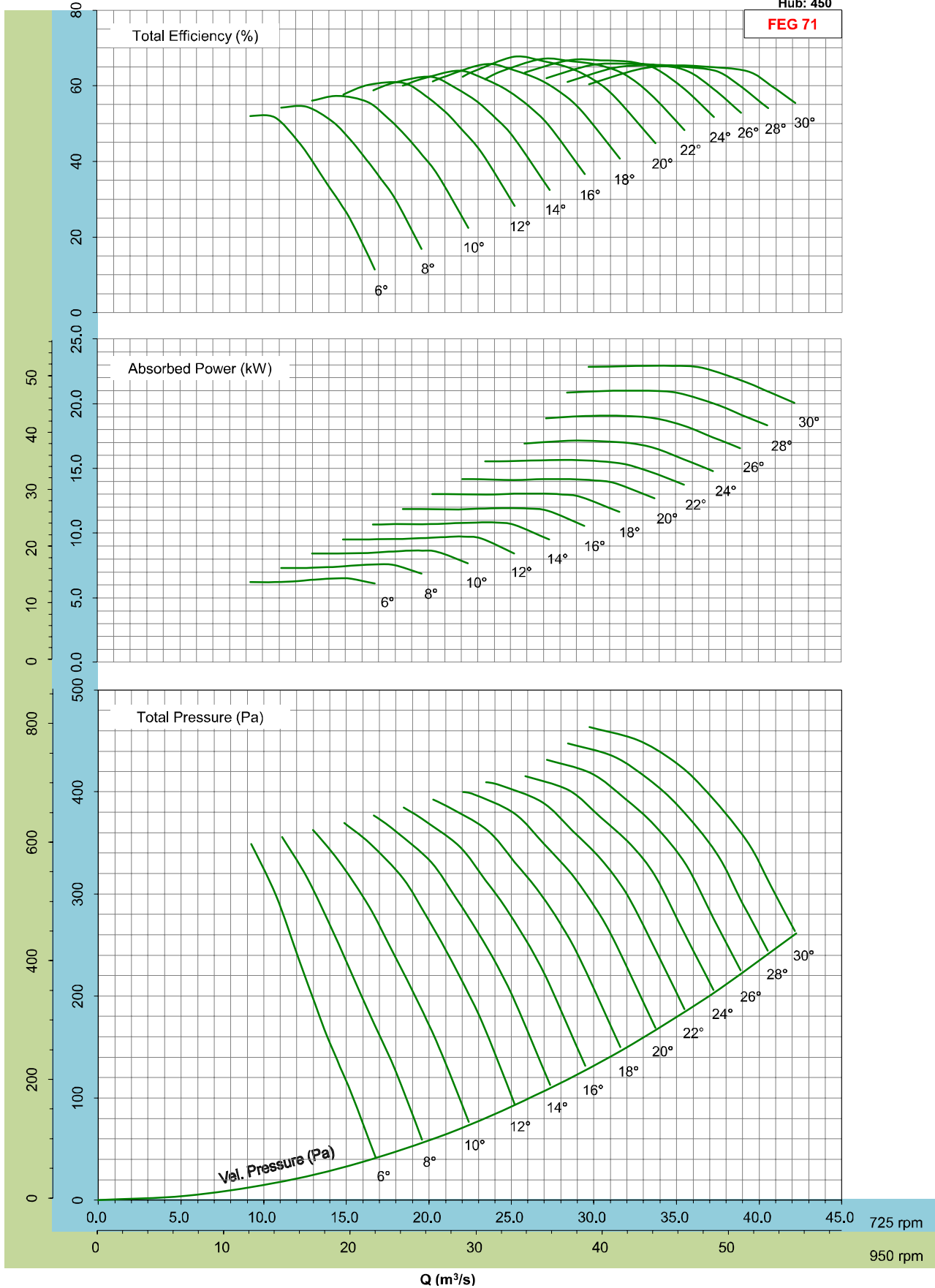

- Performance certified is for installation type D - ducted inlet, ducted outlet. Performance ratings do not include the effects of appurtenances (accessories).

TDA1600/25BL/8-8 50Hz



$\rho=1.2\text{kg/m}^3$
Hub: 450

FEG 71

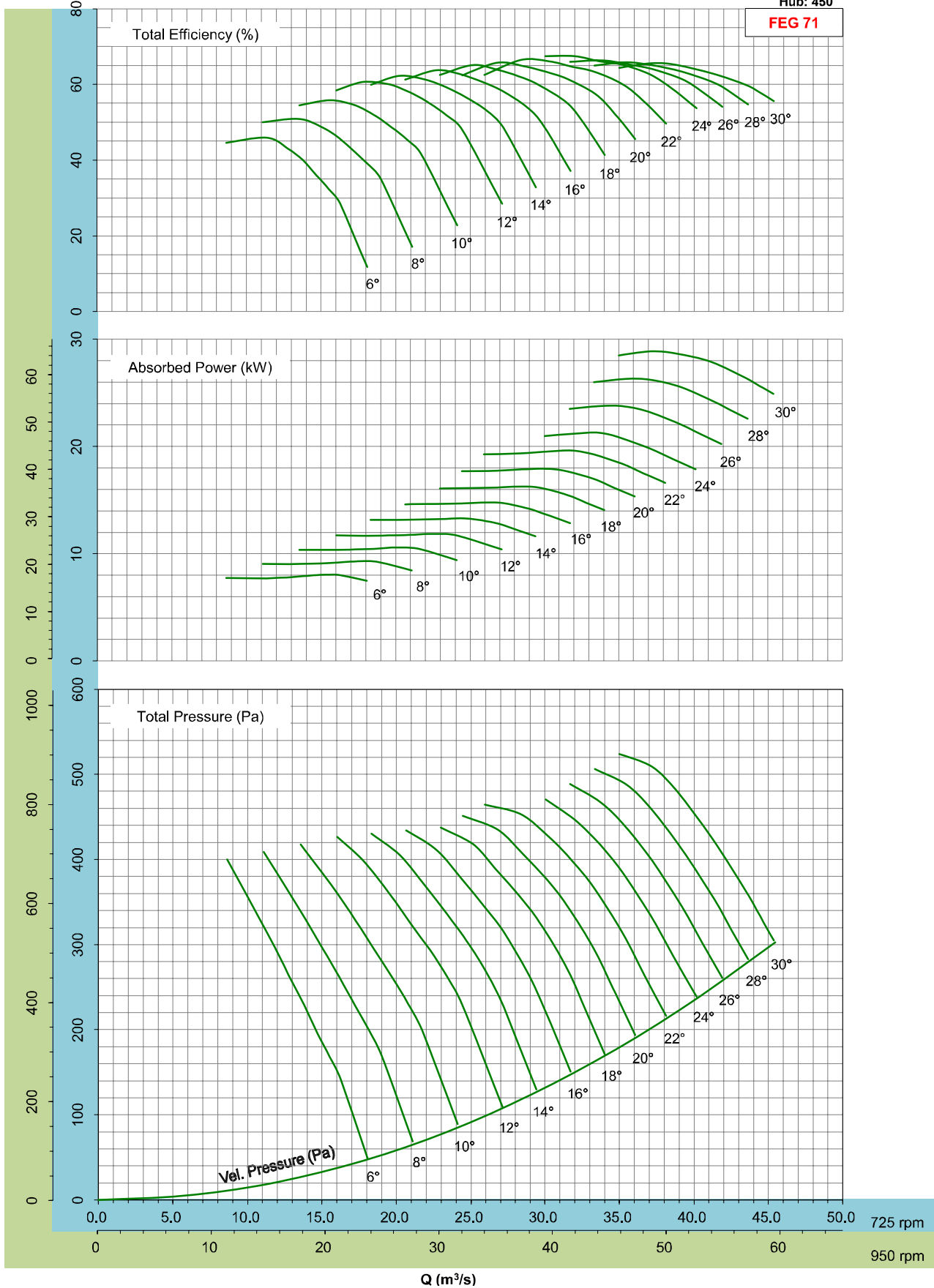

- Performance certified is for installation type D - ducted inlet, ducted outlet. Performance ratings do not include the effects of appurtenances (accessories).

TDA1600/31BL/4-4 50Hz



$\rho=1.2\text{kg/m}^3$
Hub: 450

FEG 71

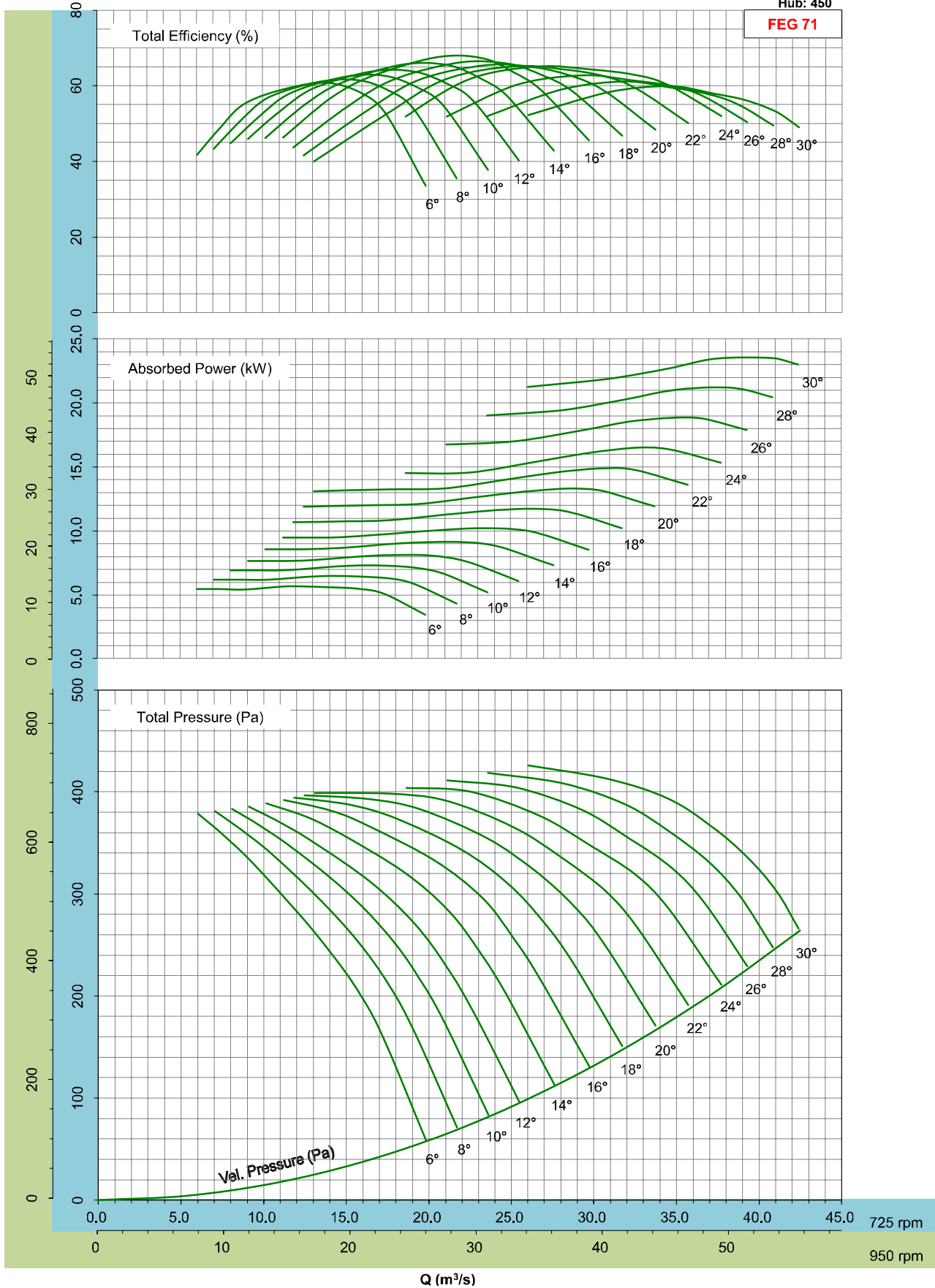

- Performance certified is for installation type D - ducted inlet, ducted outlet. Performance ratings do not include the effects of appurtenances (accessories).

TDA1600/31BL/6-6 50Hz



$\rho=1.2\text{kg/m}^3$
Hub: 450

FEG 71

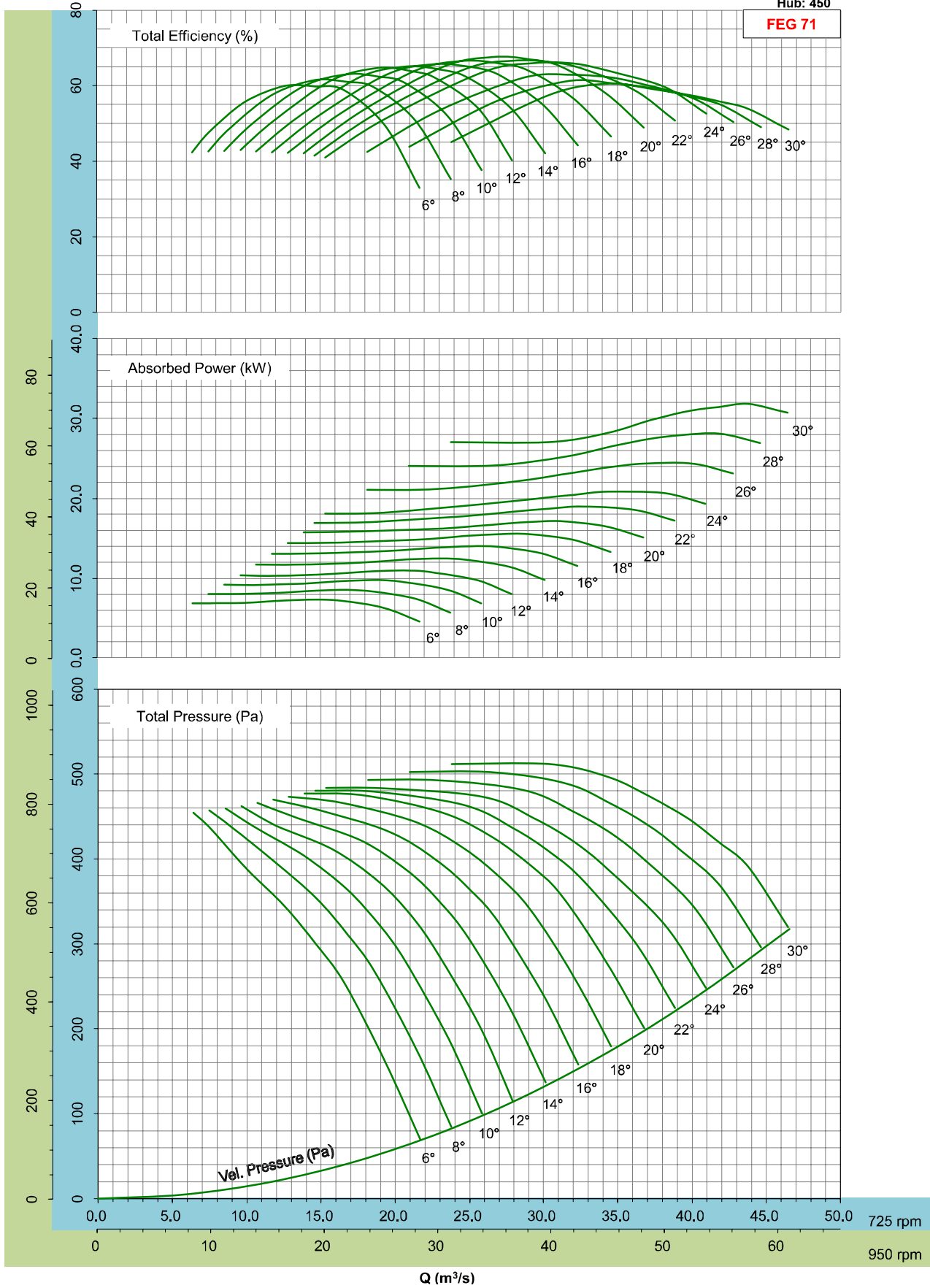

- Performance certified is for installation type D - ducted inlet, ducted outlet. Performance ratings do not include the effects of appurtenances (accessories).

TDA1600/31BL/8-8 50Hz



$\rho=1.2\text{kg/m}^3$
Hub: 450

FEG 71

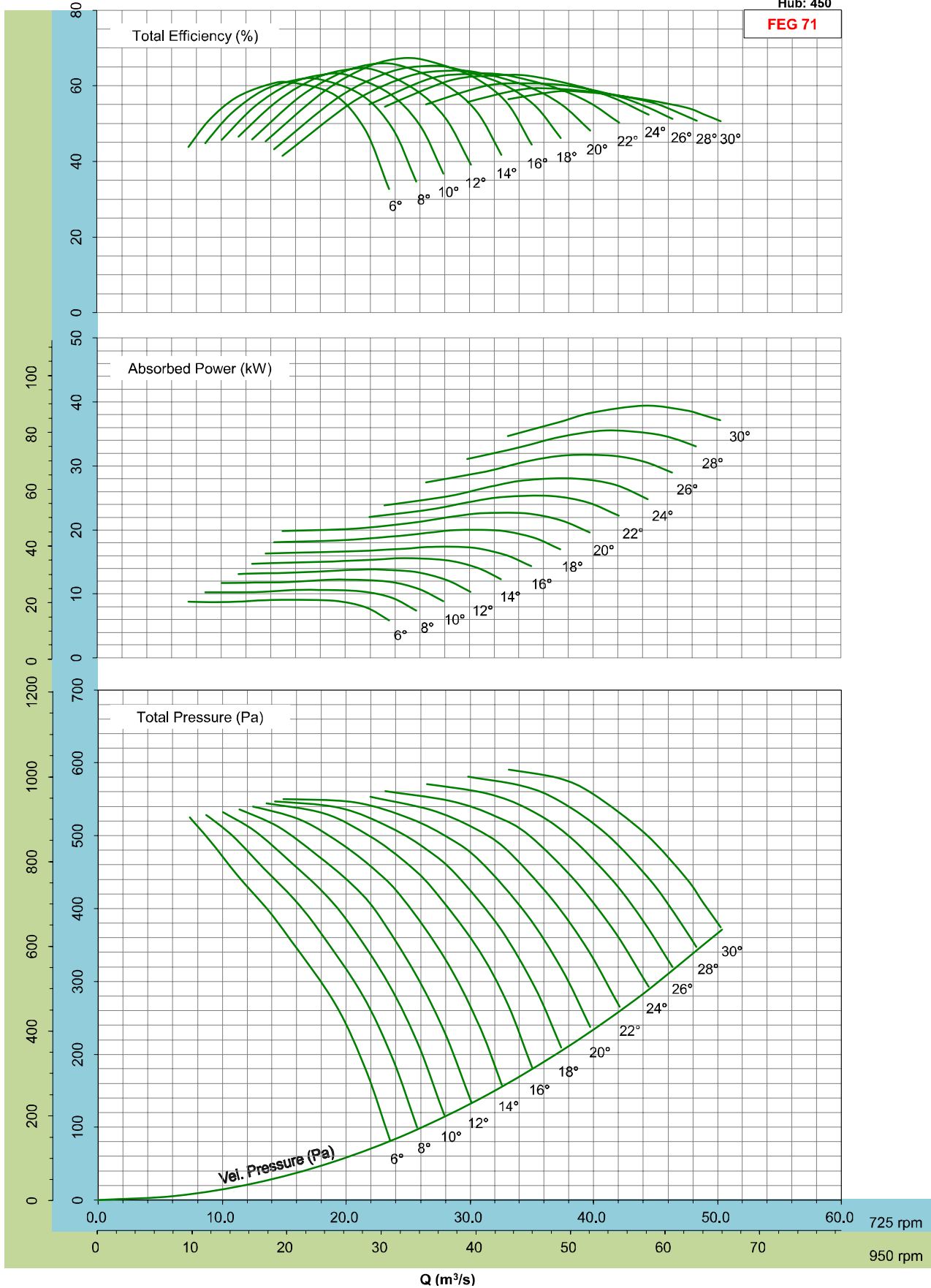

- Performance certified is for installation type D - ducted inlet, ducted outlet. Performance ratings do not include the effects of appurtenances (accessories).

TDA1800/31BM/4-4 50Hz



$\rho=1.2\text{kg/m}^3$
Hub: 502

FEG 71

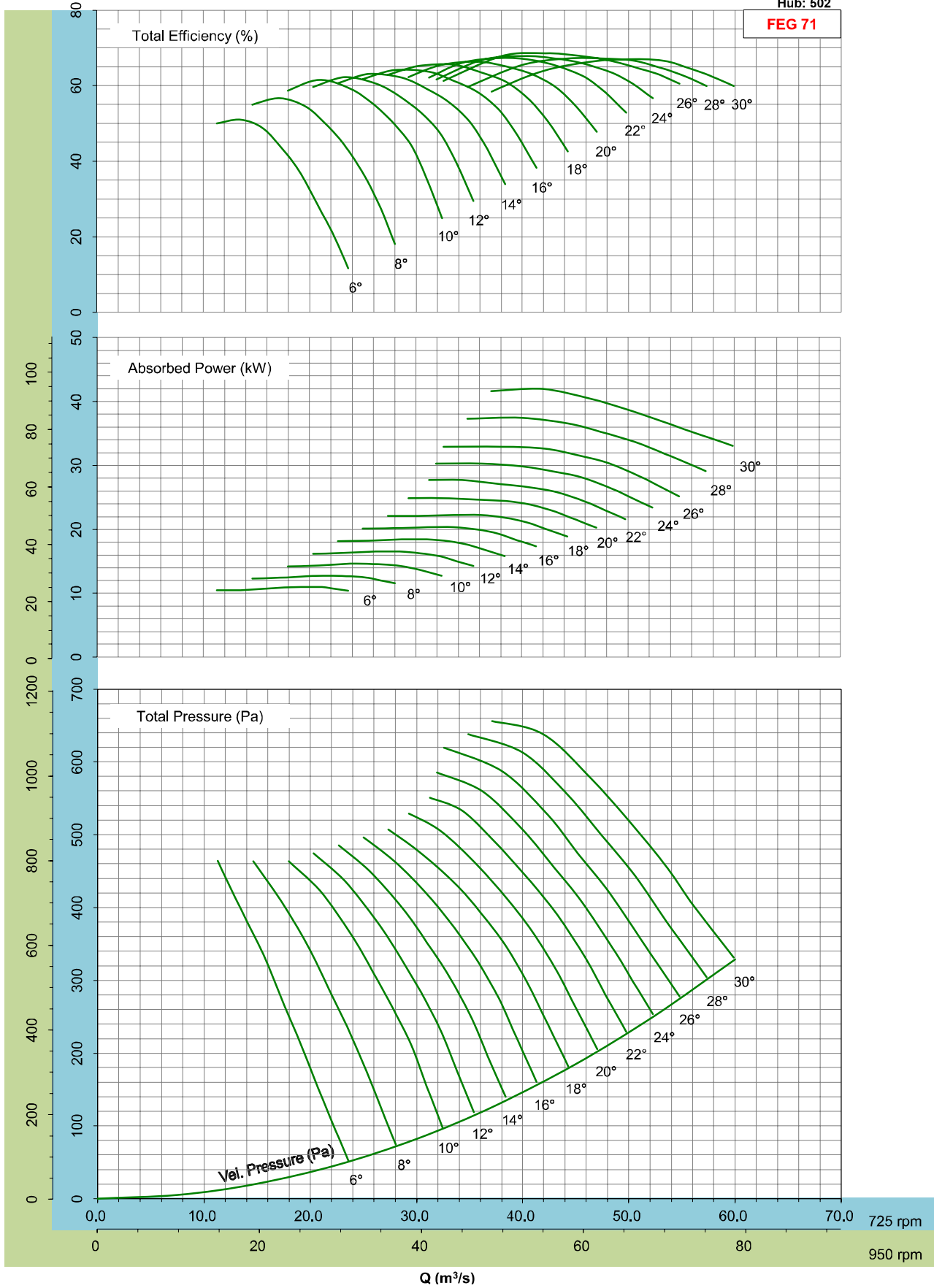

- Performance certified is for installation type D - ducted inlet, ducted outlet. Performance ratings do not include the effects of appurtenances (accessories).

TDA1800/31BM/6-6 50Hz



$\rho=1.2\text{kg/m}^3$
Hub: 502

FEG 71

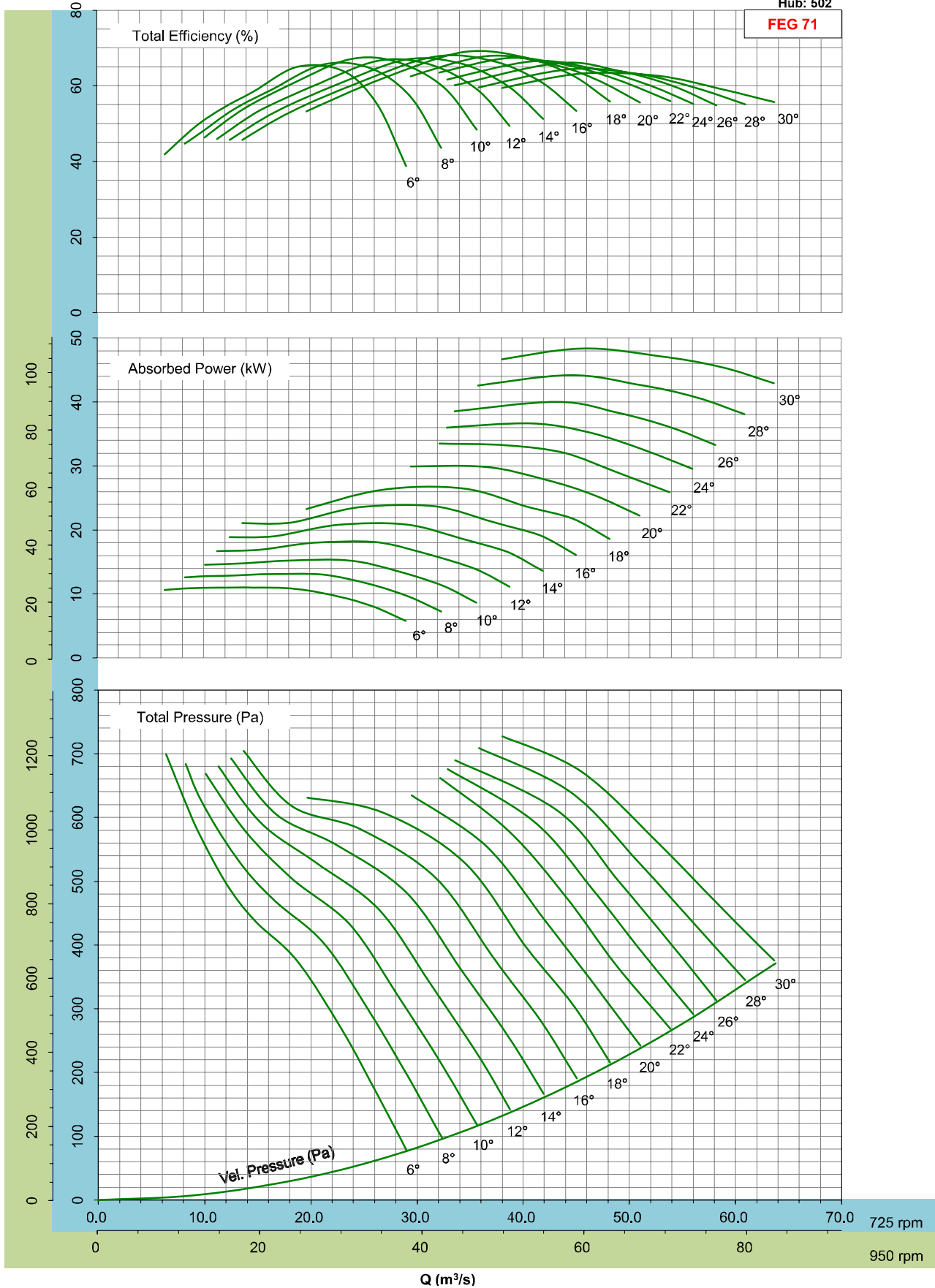

- Performance certified is for installation type D - ducted inlet, ducted outlet. Performance ratings do not include the effects of appurtenances (accessories).

TDA1800/31BM/8-8 50Hz



$\rho=1.2\text{kg/m}^3$
Hub: 502

FEG 71

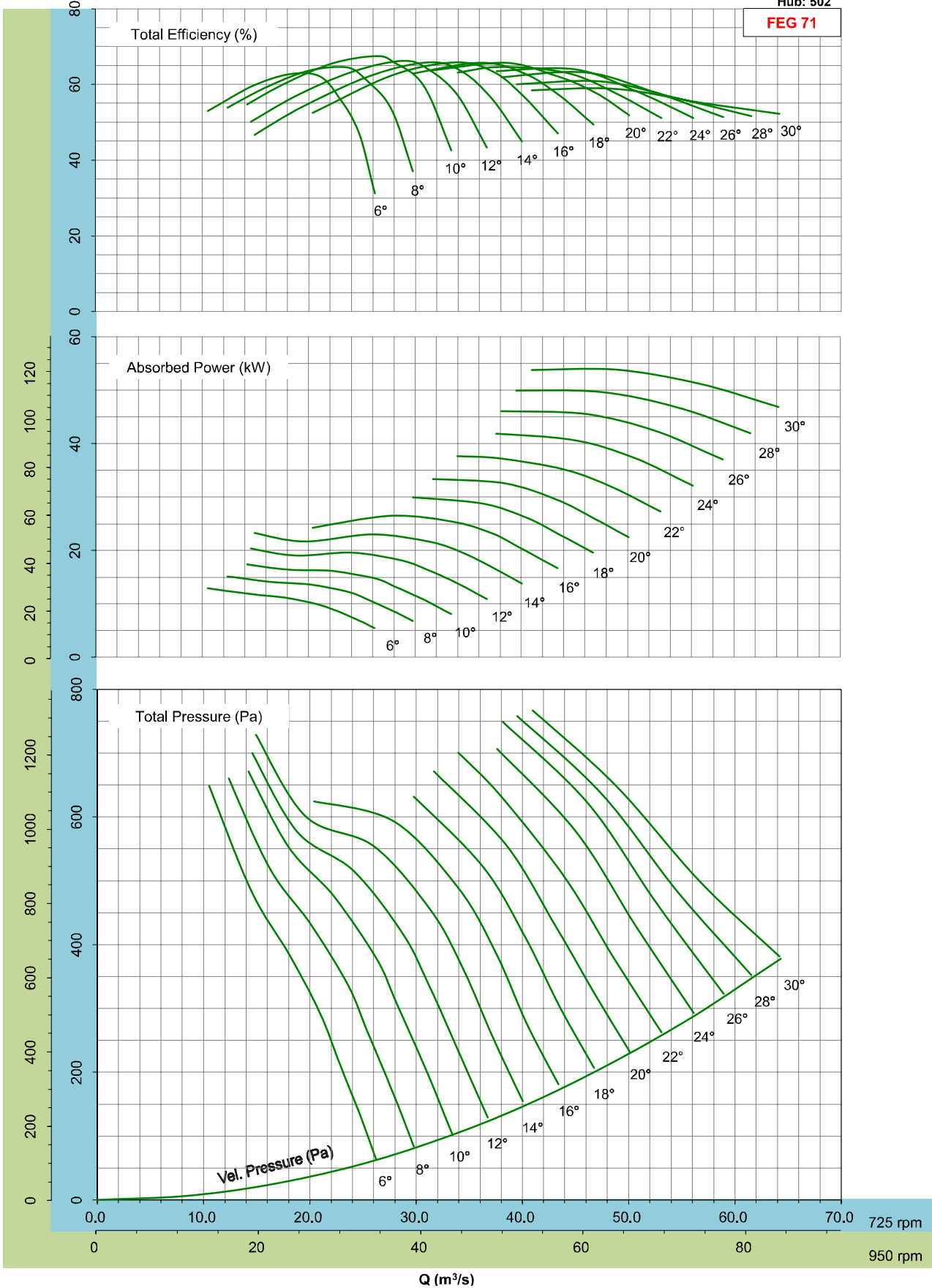

- Performance certified is for installation type D - ducted inlet, ducted outlet. Performance ratings do not include the effects of appurtenances (accessories).

TDA2000/31BN/4-4 50Hz



$\rho=1.2\text{kg/m}^3$
Hub: 560

FEG 71

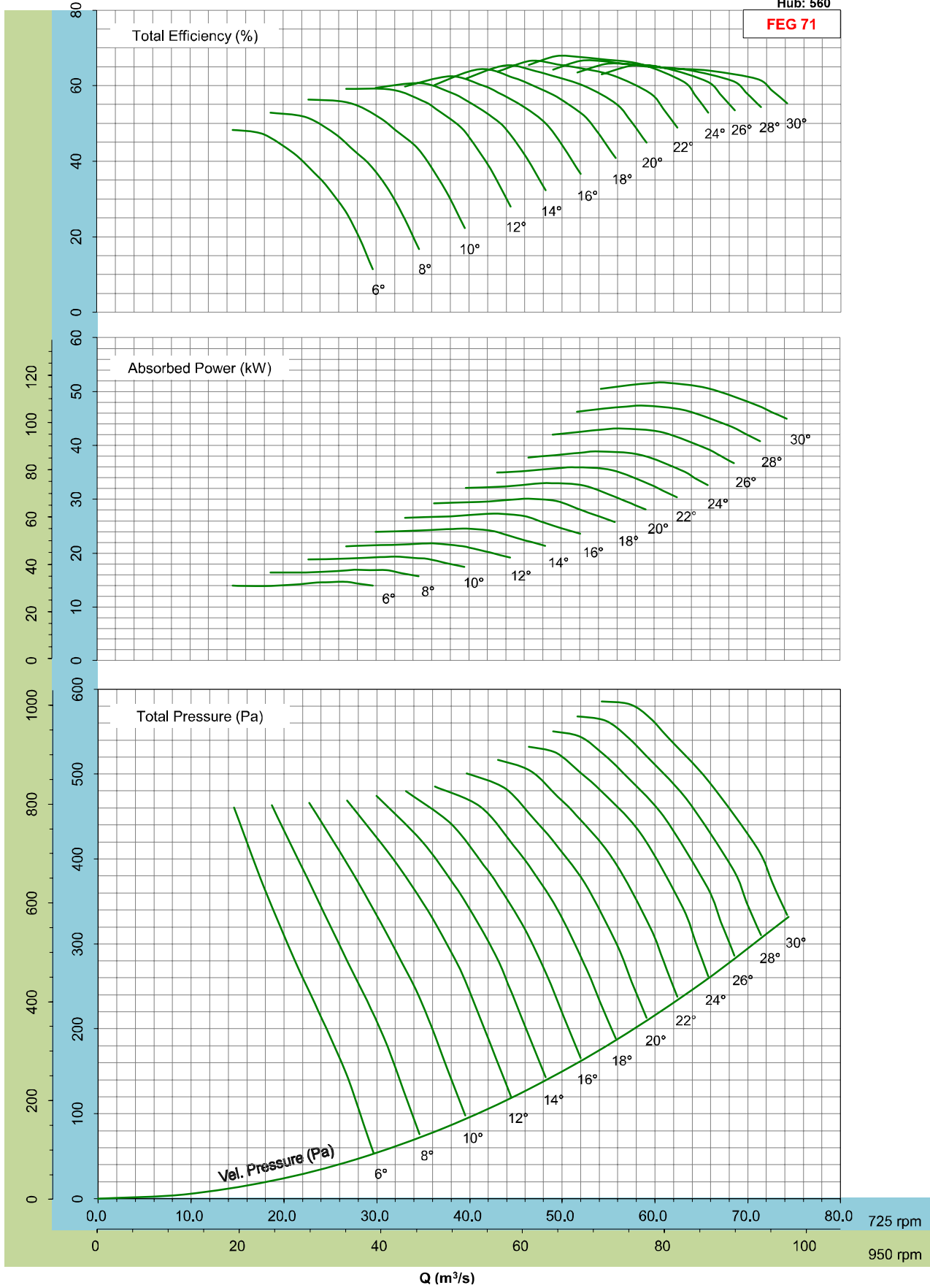

- Performance certified is for installation type D - ducted inlet, ducted outlet. Performance ratings do not include the effects of appurtenances (accessories).

- Please consult the nearest Kruger office for fan selection at 950rpm.

TDA2000/31BN/6-6 50Hz



$\rho=1.2\text{kg/m}^3$
Hub: 560

FEG 71

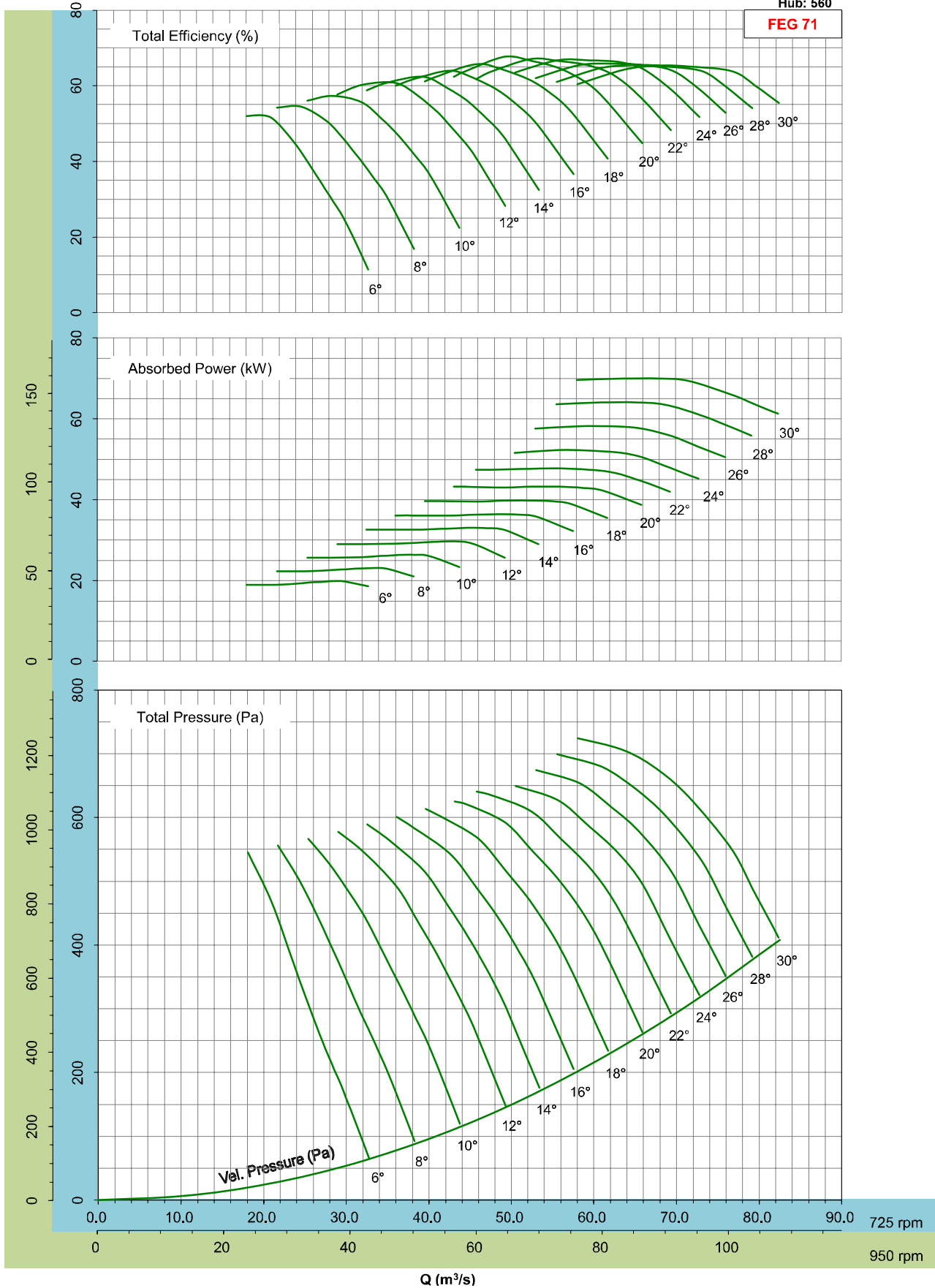

- Performance certified is for installation type D - ducted inlet, ducted outlet. Performance ratings do not include the effects of appurtenances (accessories).

- Please consult the nearest Kruger office for fan selection at 950rpm.

TDA2000/31BN/8-8 50Hz



$\rho=1.2\text{kg/m}^3$
Hub: 560

FEG 71

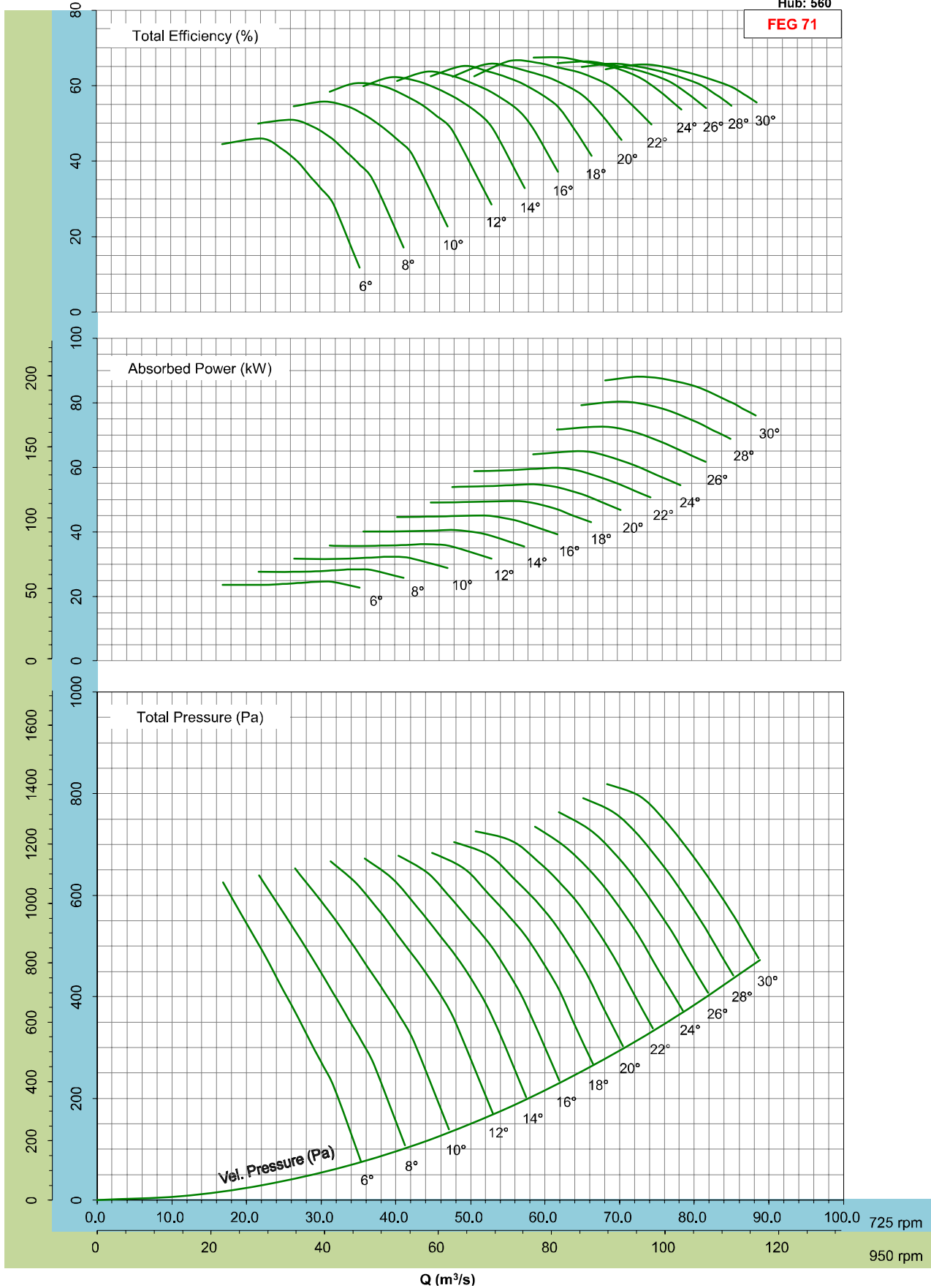

- Performance certified is for installation type D - ducted inlet, ducted outlet. Performance ratings do not include the effects of appurtenances (accessories).

- Please consult the nearest Kruger office for fan selection at 950rpm.

TDA630/12AA/7-7 60Hz



$\rho=1.2\text{kg/m}^3$
Hub: 186

FEG 71

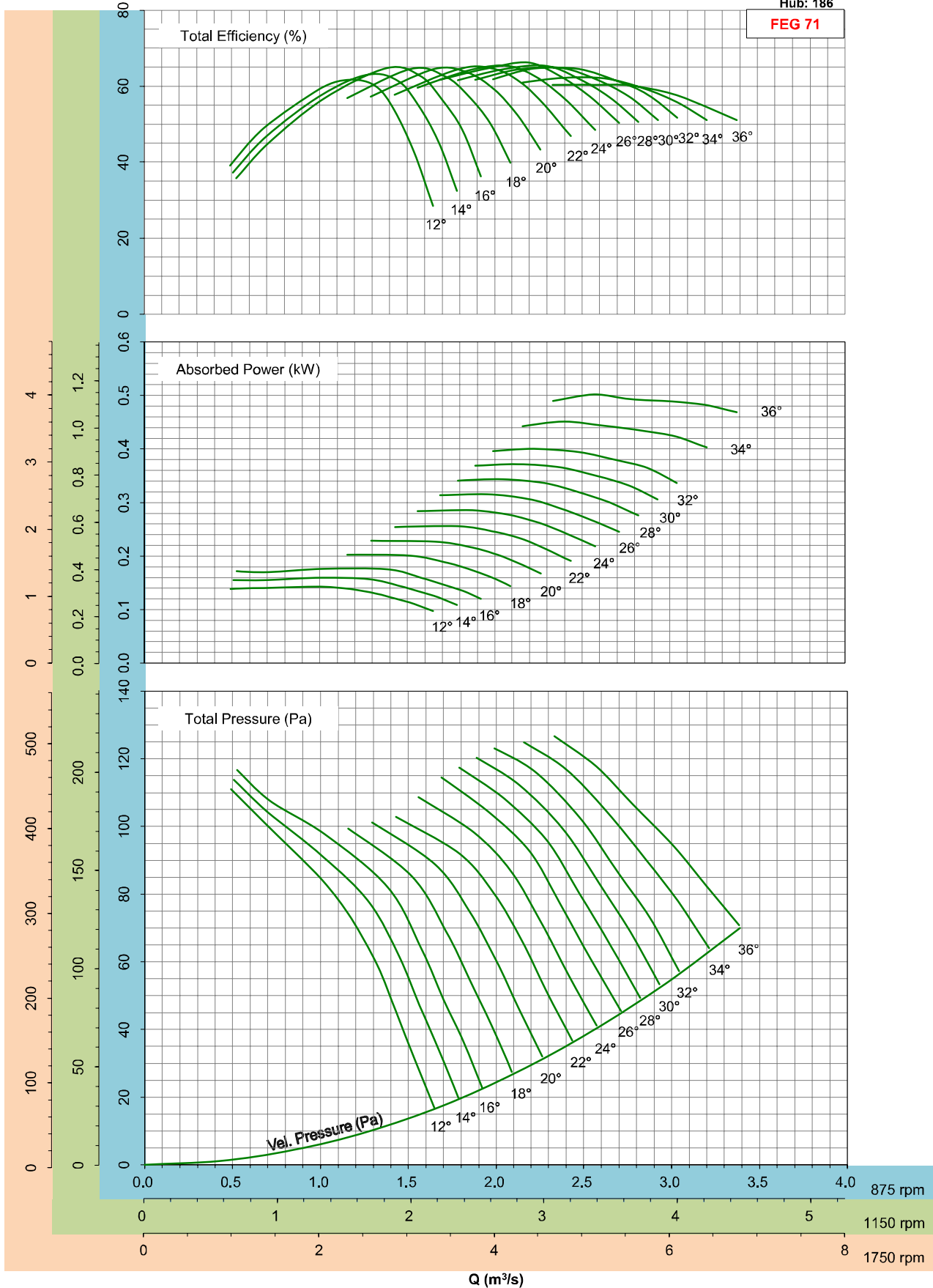

- Performance certified is for installation type D - ducted inlet, ducted outlet. Performance ratings do not include the effects of appurtenances (accessories).

TDA630/12AA/9-9 60Hz



$\rho=1.2\text{kg/m}^3$
Hub: 200

FEG 71

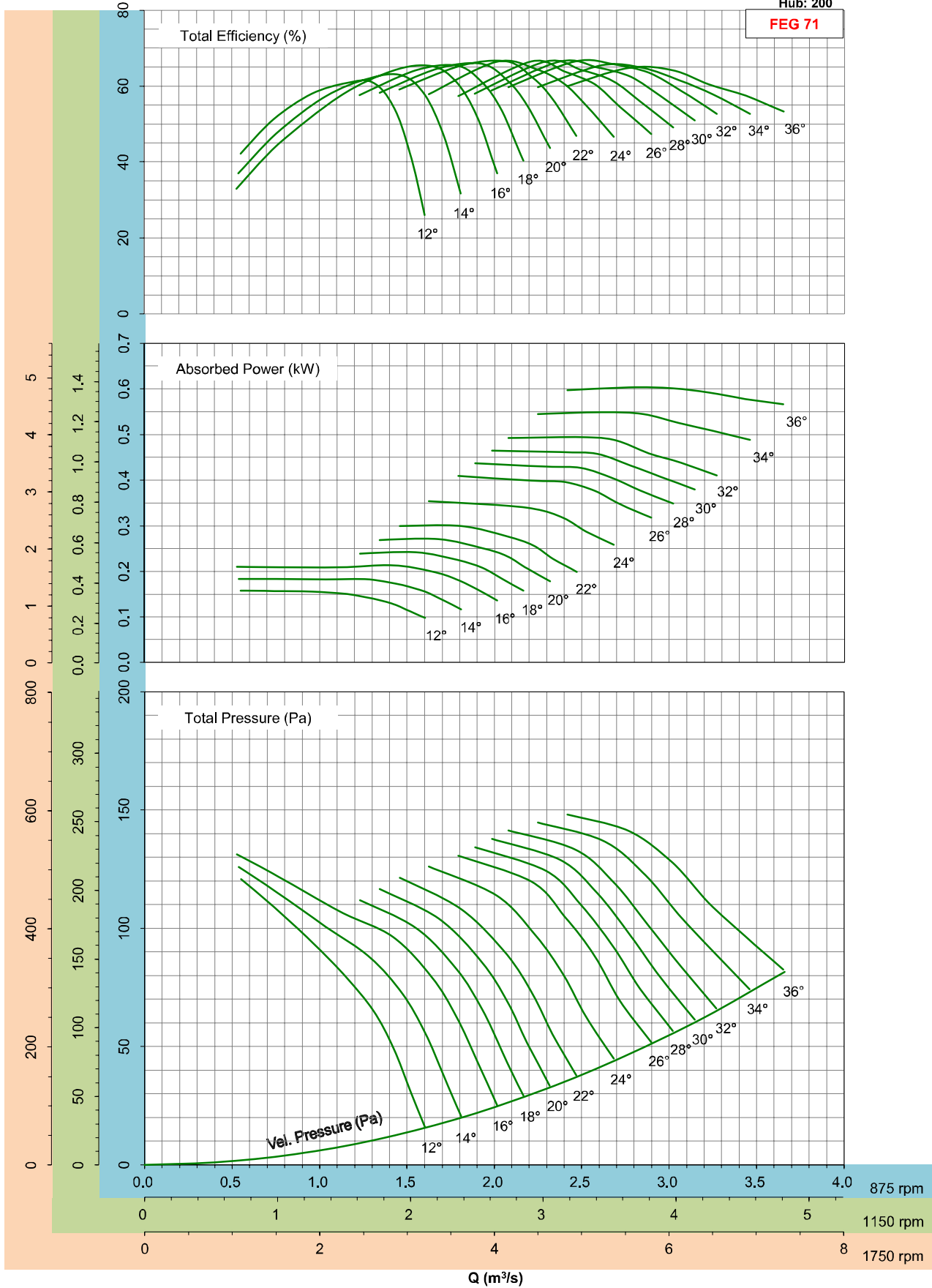

- Performance certified is for installation type D - ducted inlet, ducted outlet. Performance ratings do not include the effects of appurtenances (accessories).

TDA710/12AA/7-7 60Hz



$\rho=1.2\text{kg/m}^3$
Hub: 186

FEG 71

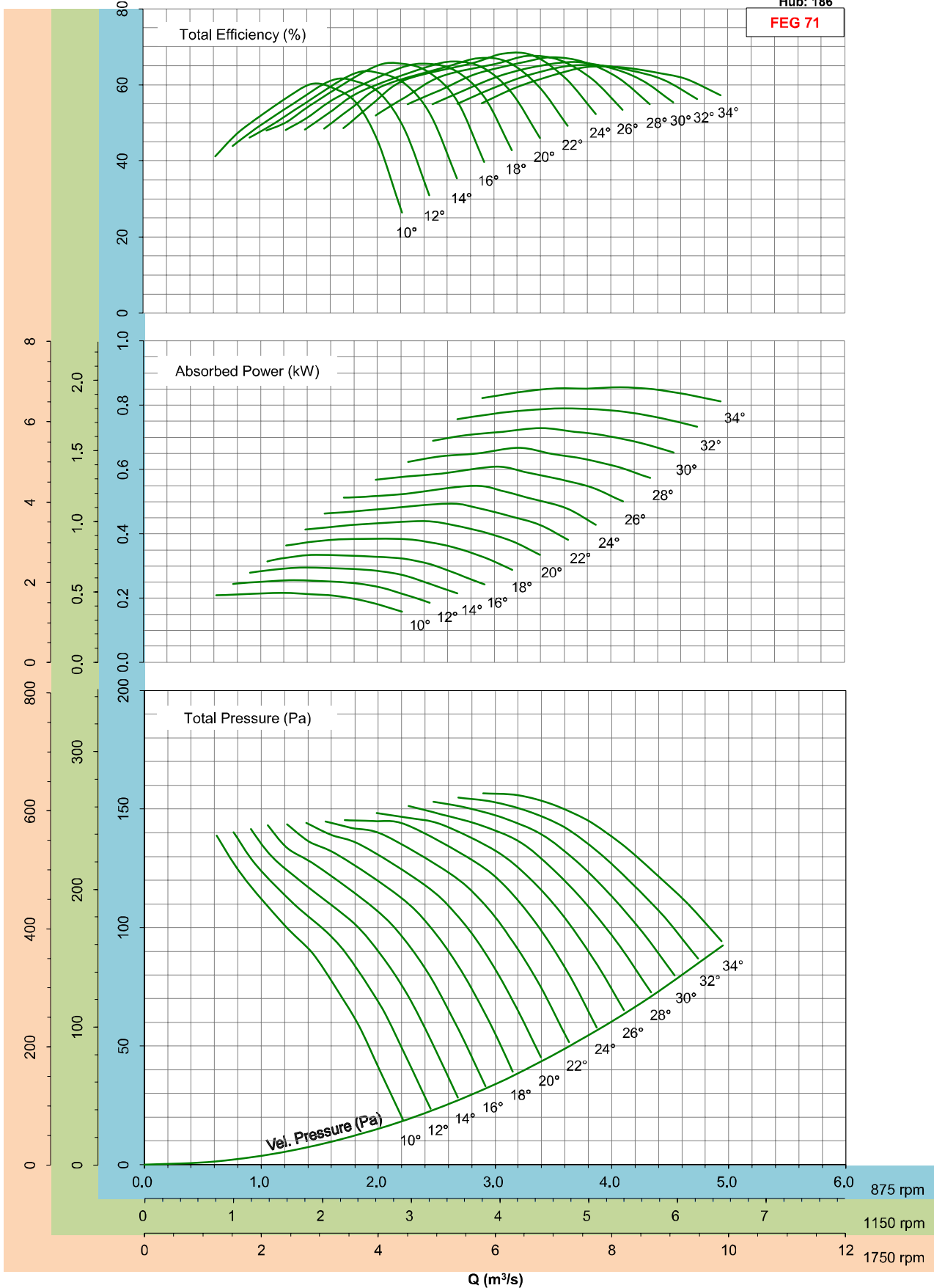

- Performance certified is for installation type D - ducted inlet, ducted outlet. Performance ratings do not include the effects of appurtenances (accessories).

TDA710/12AA/9-9 60Hz



$\rho=1.2\text{kg/m}^3$
Hub: 200

FEG 71

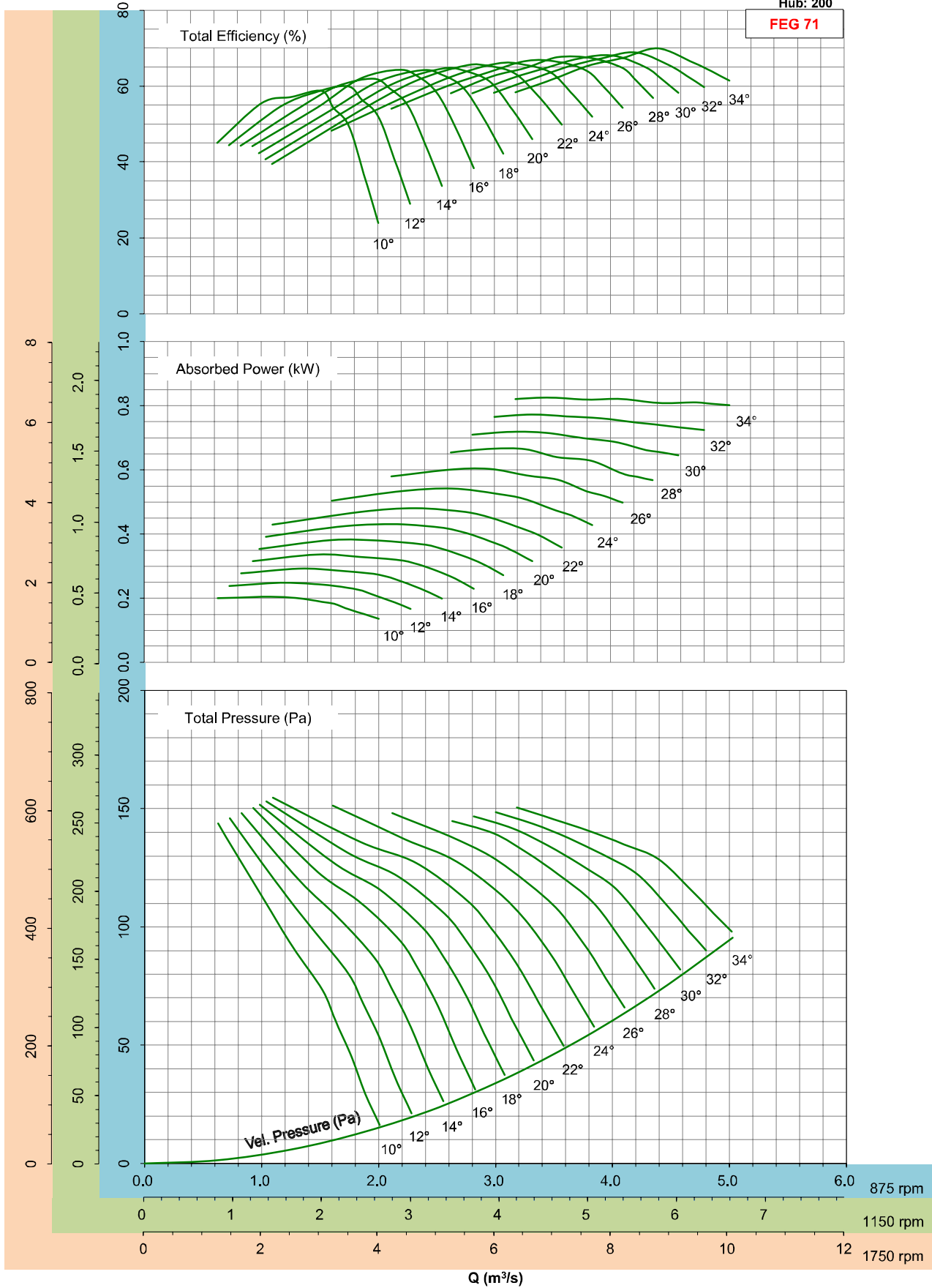

- Performance certified is for installation type D - ducted inlet, ducted outlet. Performance ratings do not include the effects of appurtenances (accessories).

TDA710/14AA/7-7 60Hz



$\rho=1.2\text{kg/m}^3$
Hub: 186

FEG 71

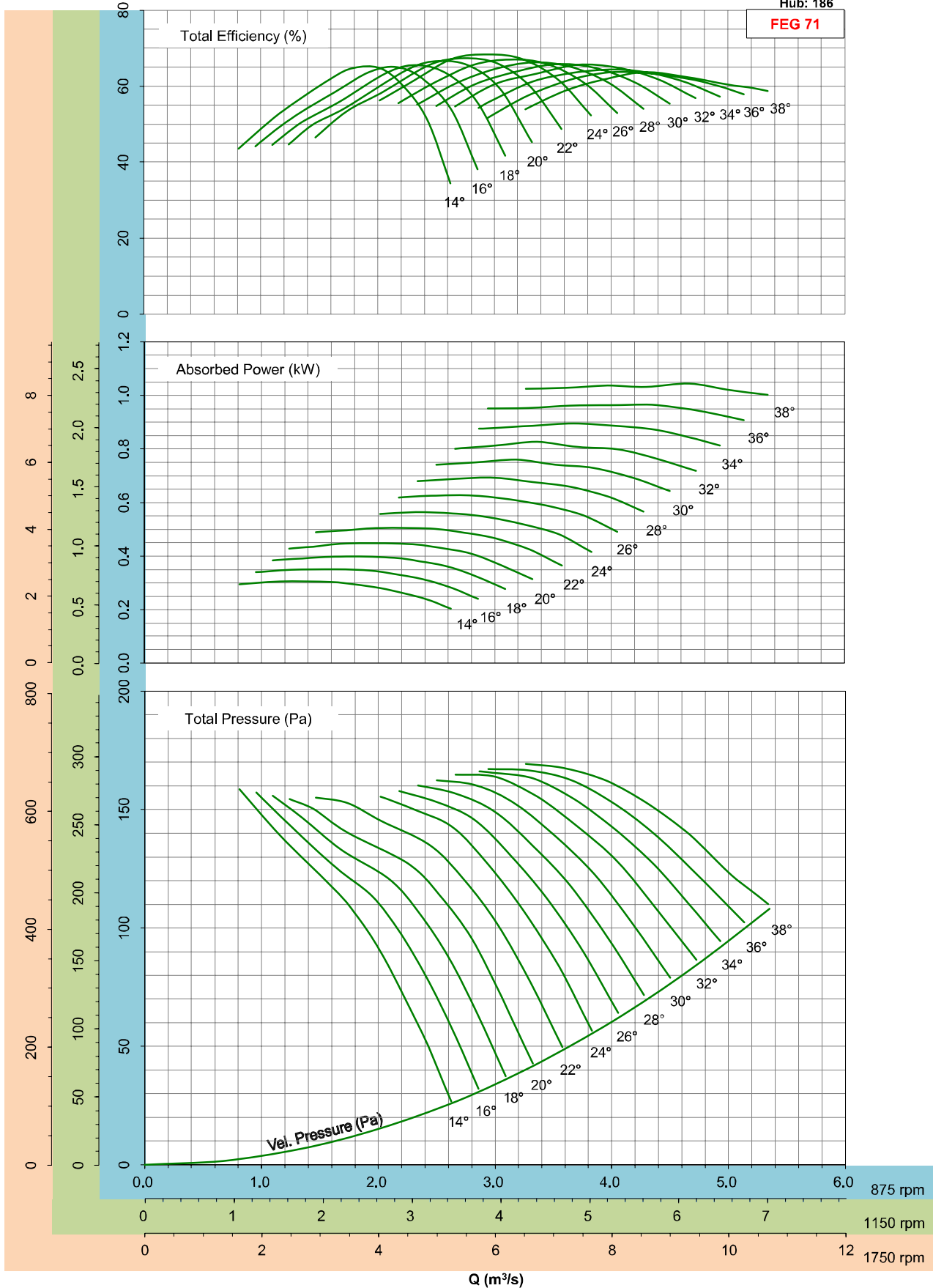

- Performance certified is for installation type D - ducted inlet, ducted outlet. Performance ratings do not include the effects of appurtenances (accessories).

TDA800/12AA/7-7 60Hz



$\rho=1.2\text{kg/m}^3$
Hub: 186

FEG 71

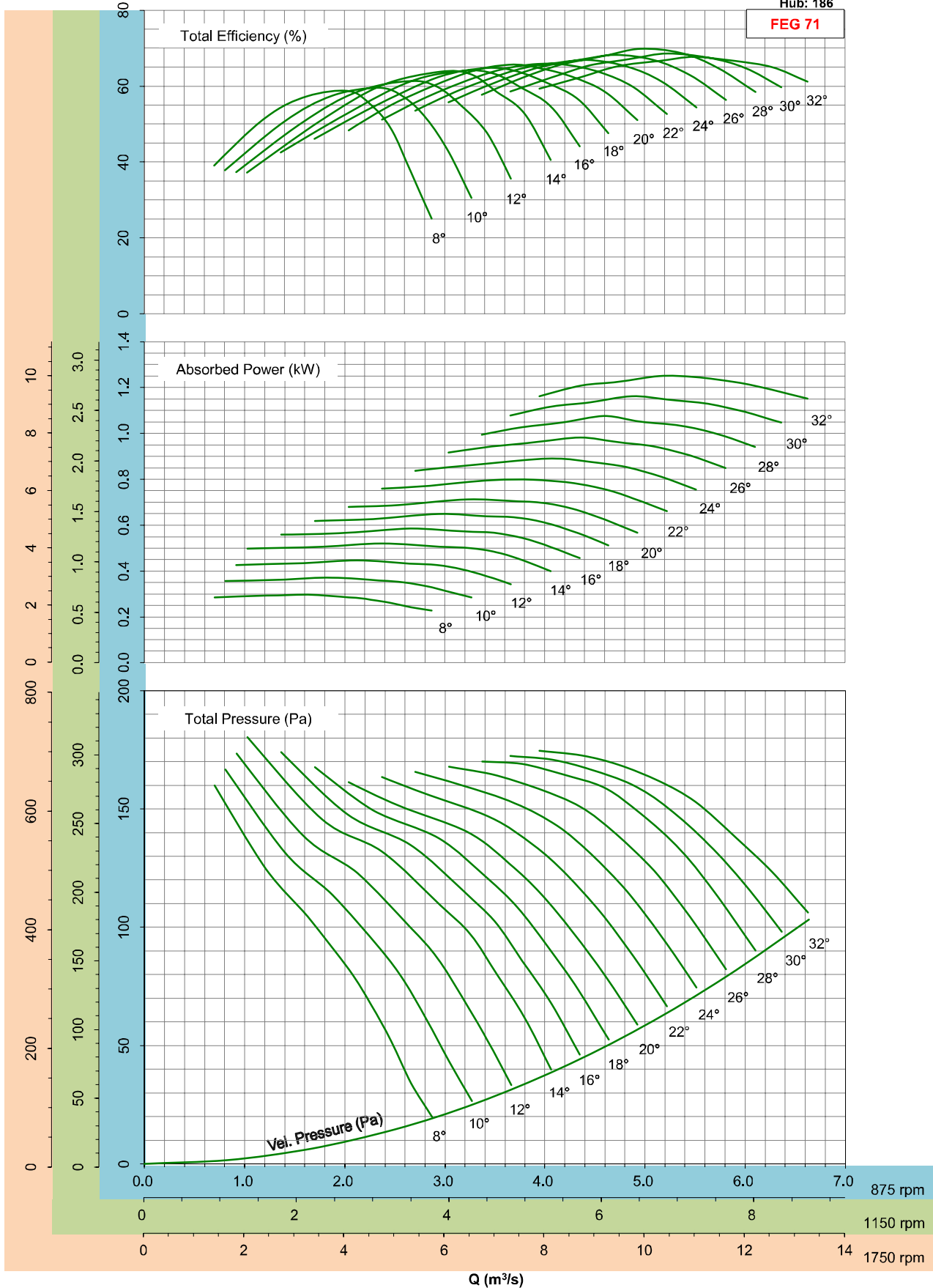

- Performance certified is for installation type D - ducted inlet, ducted outlet. Performance ratings do not include the effects of appurtenances (accessories).

TDA900/12AA/12-12 60Hz



$\rho=1.2\text{kg/m}^3$
Hub: 280

FEG 71

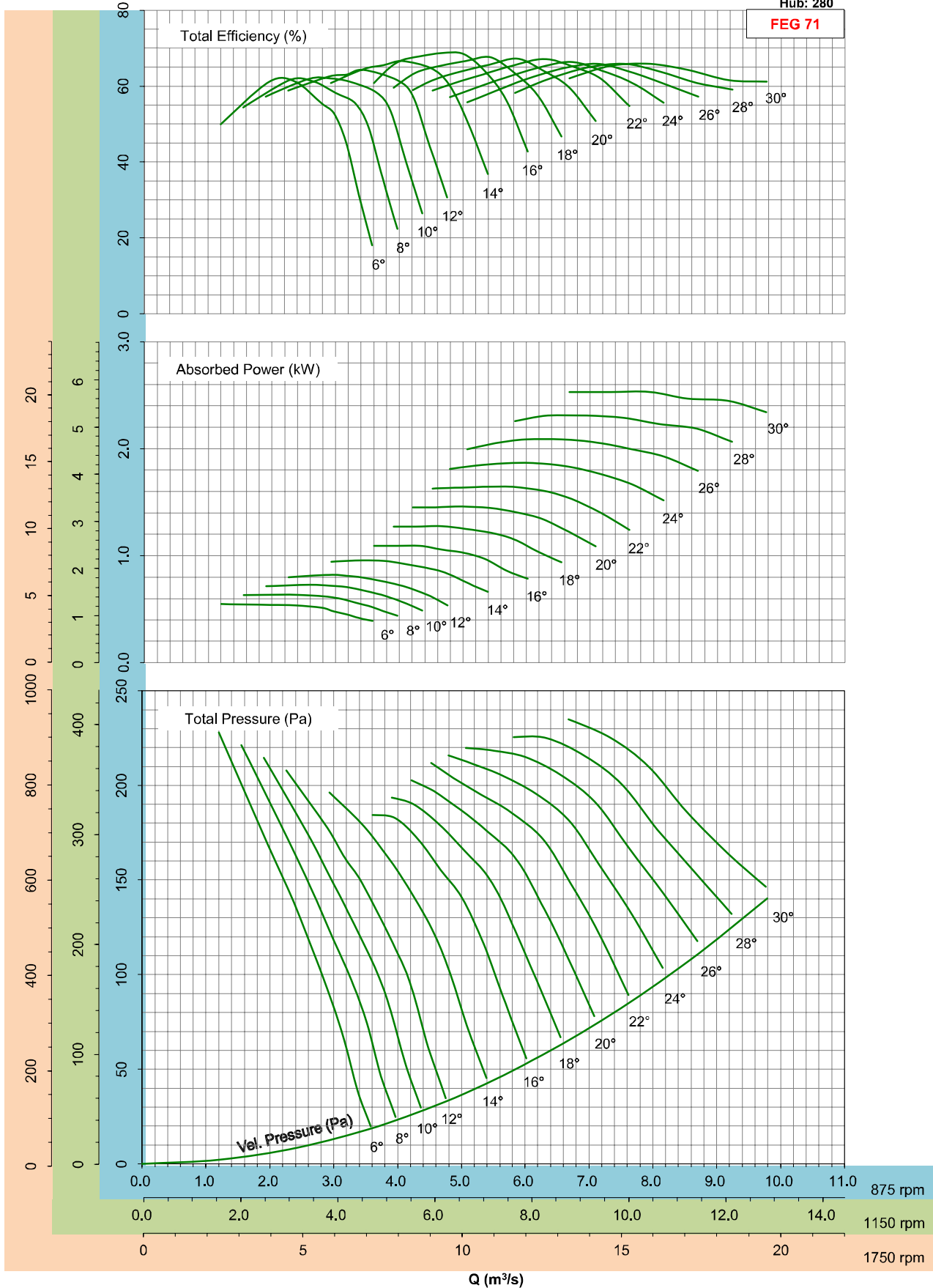

- Performance certified is for installation type D - ducted inlet, ducted outlet. Performance ratings do not include the effects of appurtenances (accessories).

TDA900/14AA/7-7 60Hz



$\rho=1.2\text{kg/m}^3$
Hub: 186

FEG 71

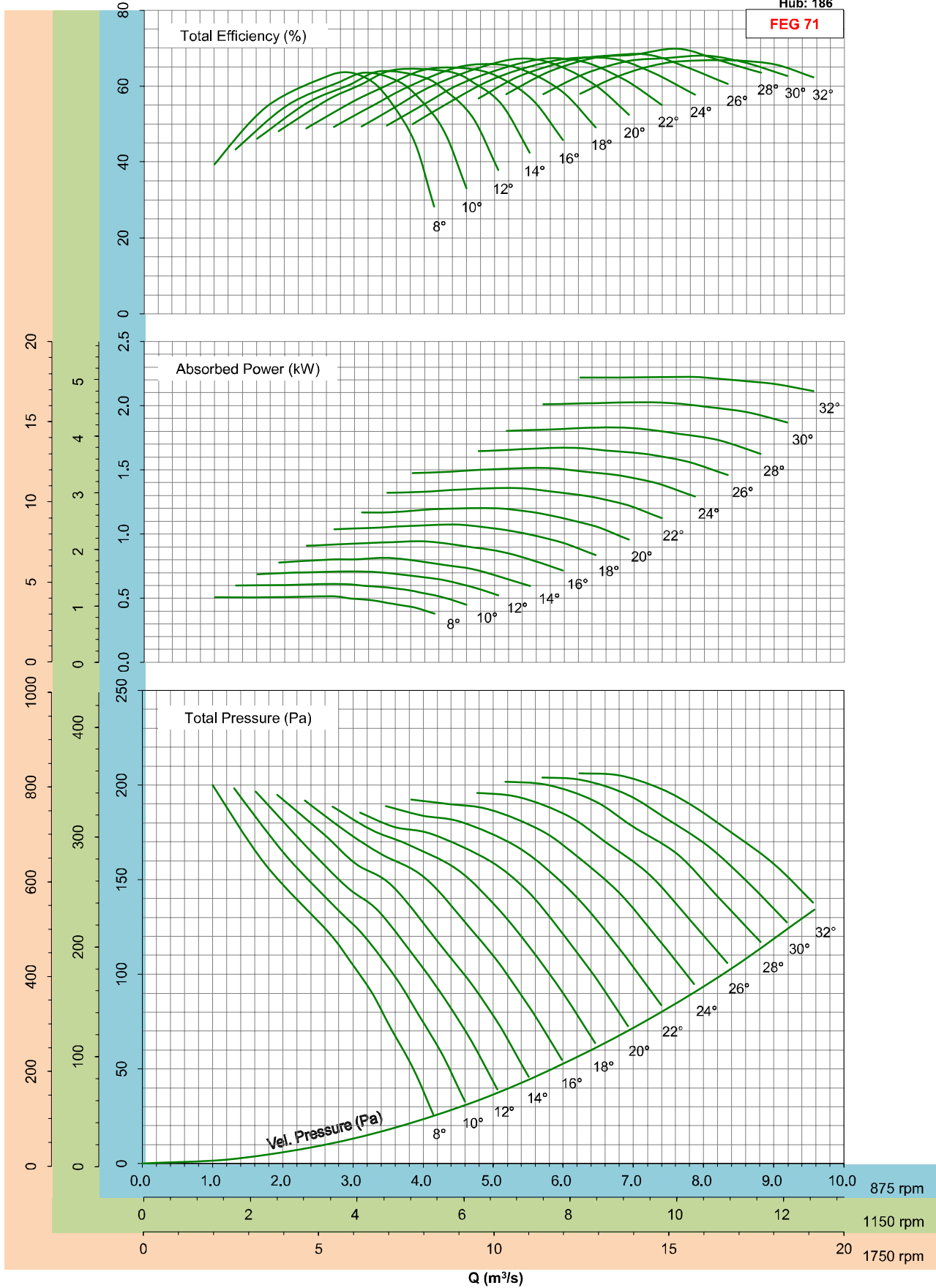

- Performance certified is for installation type D - ducted inlet, ducted outlet. Performance ratings do not include the effects of appurtenances (accessories).

TDA900/14AA/8-8 60Hz



$\rho=1.2\text{kg/m}^3$
Hub: 266

FEG 71

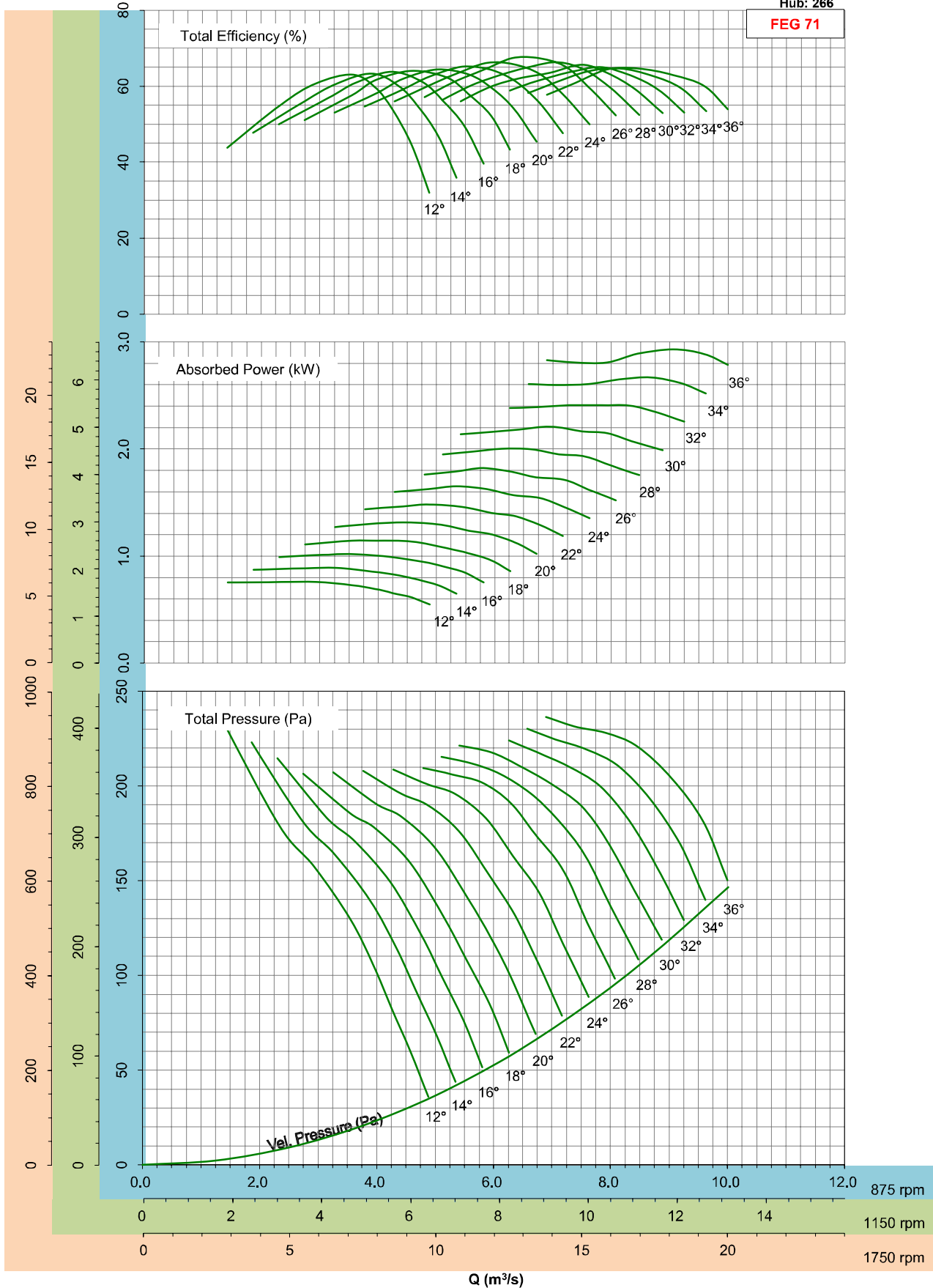

- Performance certified is for installation type D - ducted inlet, ducted outlet. Performance ratings do not include the effects of appurtenances (accessories).

TDA900/14AA/9-9 60Hz



$\rho=1.2\text{kg/m}^3$
Hub: 200

FEG 71

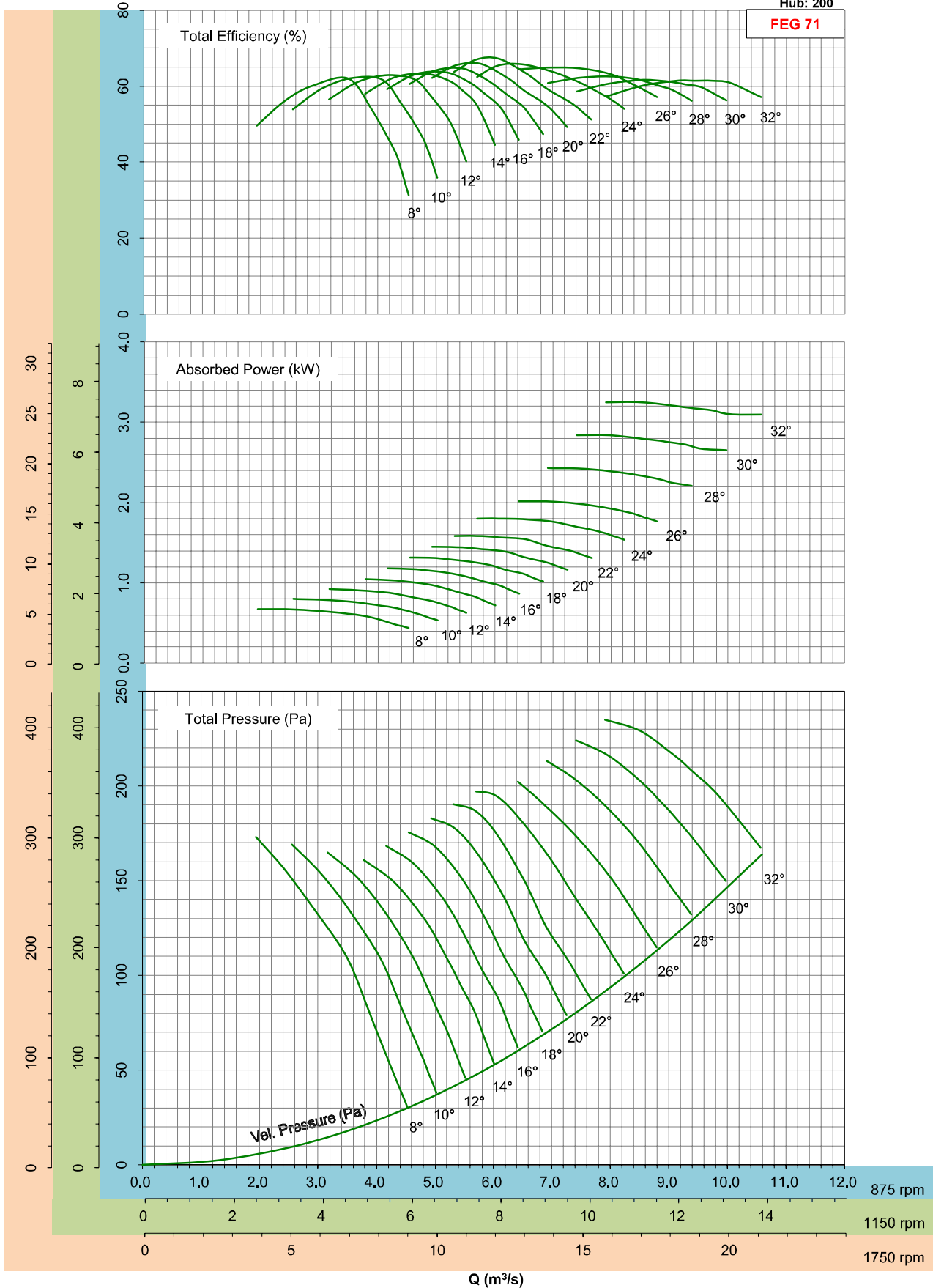

- Performance certified is for installation type D - ducted inlet, ducted outlet. Performance ratings do not include the effects of appurtenances (accessories).

TDA1000/14AA/6-12 60Hz



$\rho=1.2\text{kg/m}^3$
Hub: 280

FEG 75

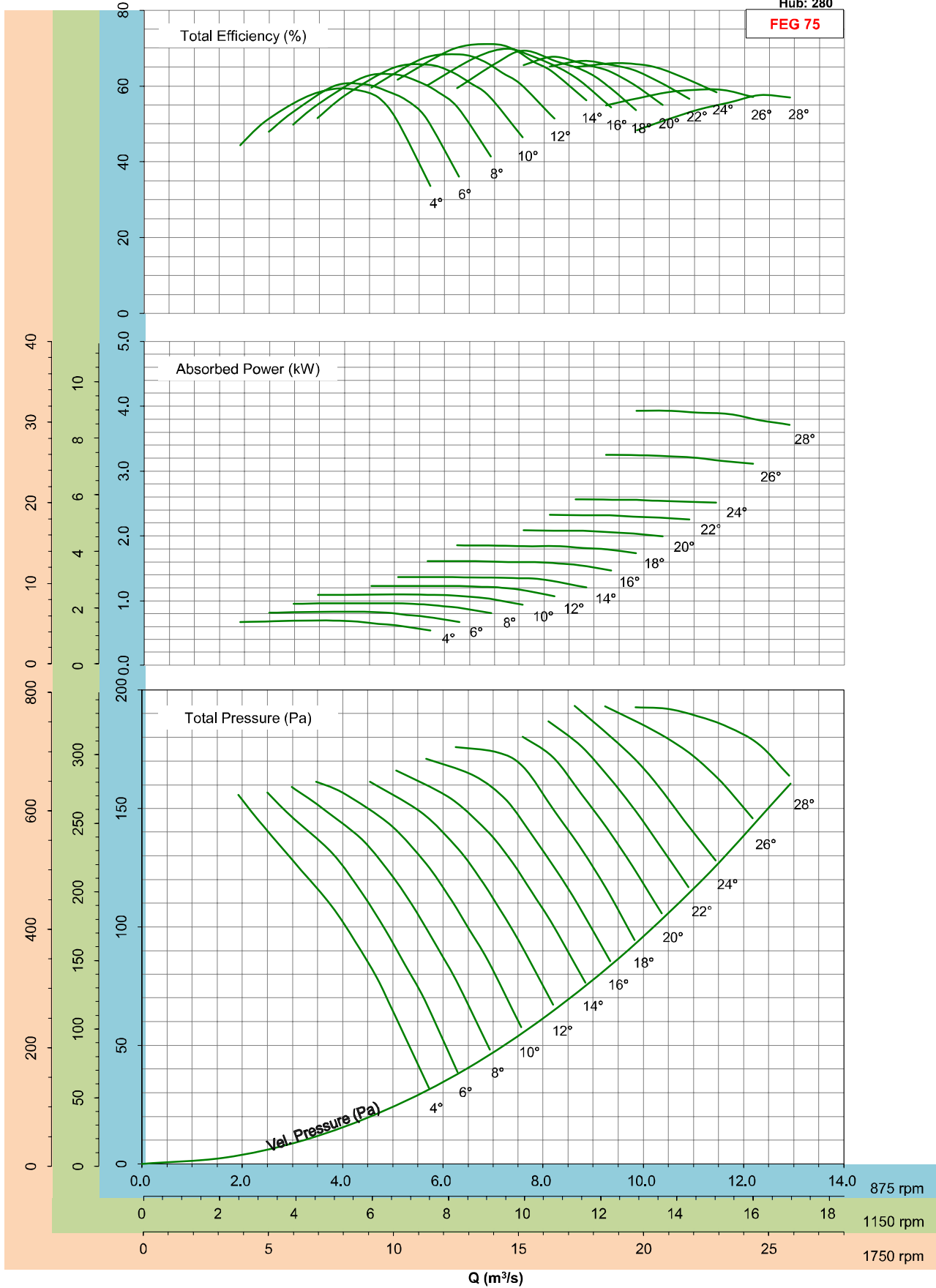

- Performance certified is for installation type D - ducted inlet, ducted outlet. Performance ratings do not include the effects of appurtenances (accessories).

- Please consult the nearest Kruger office for fan selection at 1750rpm.

TDA1000/14AA/7-7 60Hz



$\rho=1.2\text{kg/m}^3$
Hub: 186

FEG 75

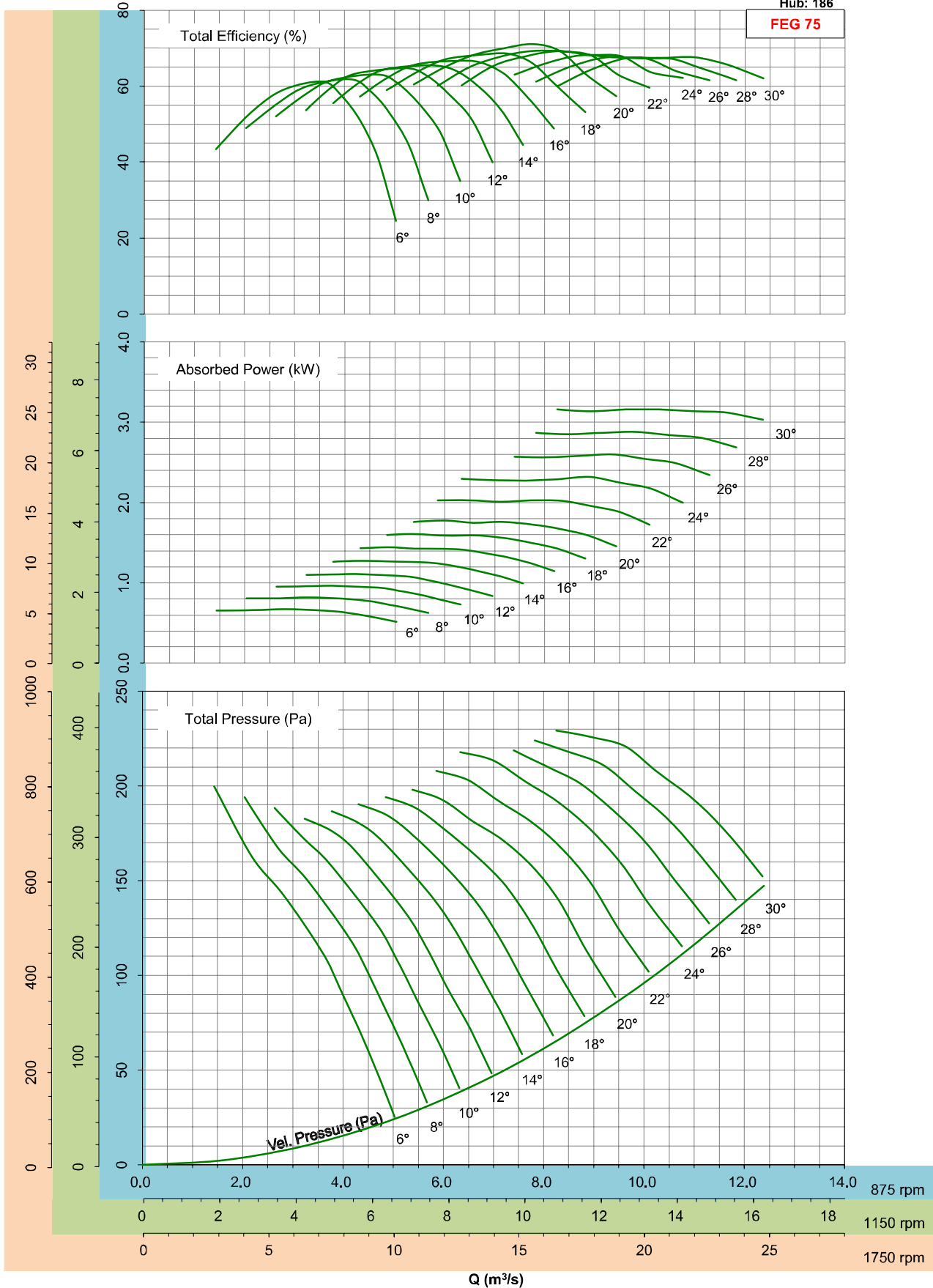

- Performance certified is for installation type D - ducted inlet, ducted outlet. Performance ratings do not include the effects of appurtenances (accessories).

- Please consult the nearest Kruger office for fan selection at 1750rpm.

TDA1000/14AA/9-9 60Hz



$\rho=1.2\text{kg/m}^3$
Hub: 200

FEG 75

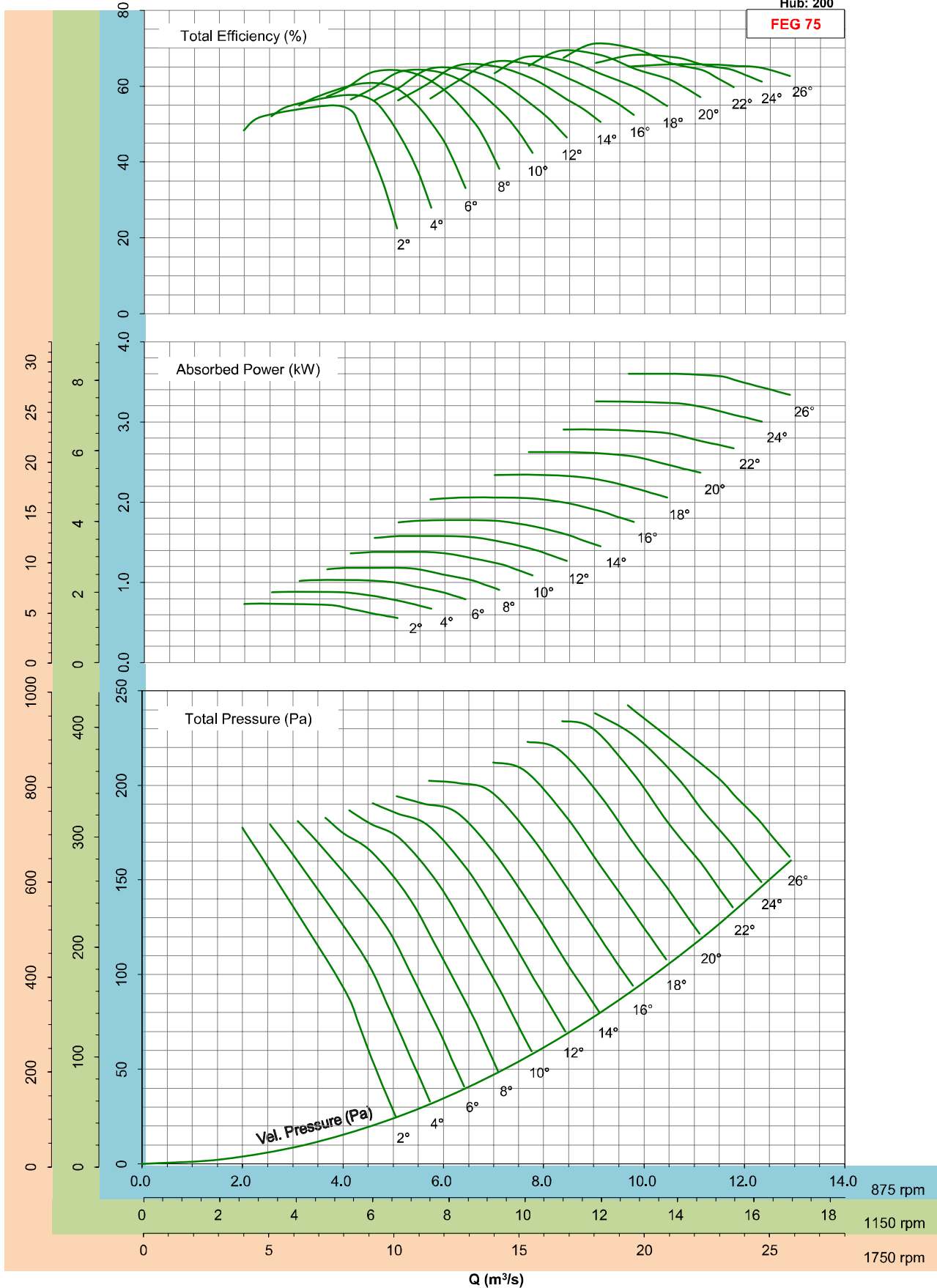

- Performance certified is for installation type D - ducted inlet, ducted outlet. Performance ratings do not include the effects of appurtenances (accessories).

- Please consult the nearest Kruger office for fan selection at 1750rpm.

TDA1000/20BH/4-4 60Hz



$\rho=1.2\text{kg/m}^3$
Hub: 280

FEG 71

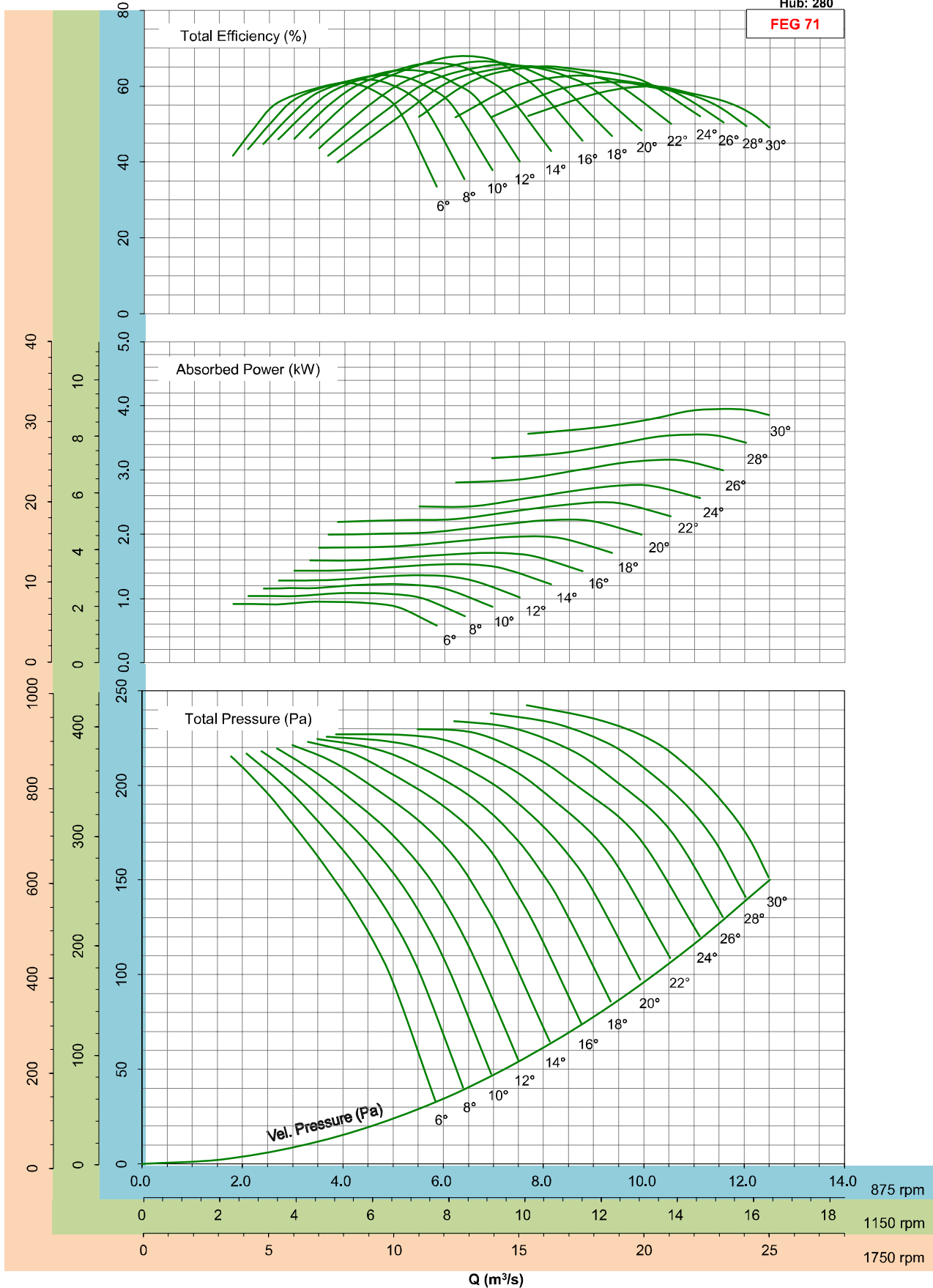

- Performance certified is for installation type D - ducted inlet, ducted outlet. Performance ratings do not include the effects of appurtenances (accessories).

- Please consult the nearest Kruger office for fan selection at 1750rpm.

TDA1000/20BH/6-6 60Hz



$\rho=1.2\text{kg/m}^3$
Hub: 280

FEG 71

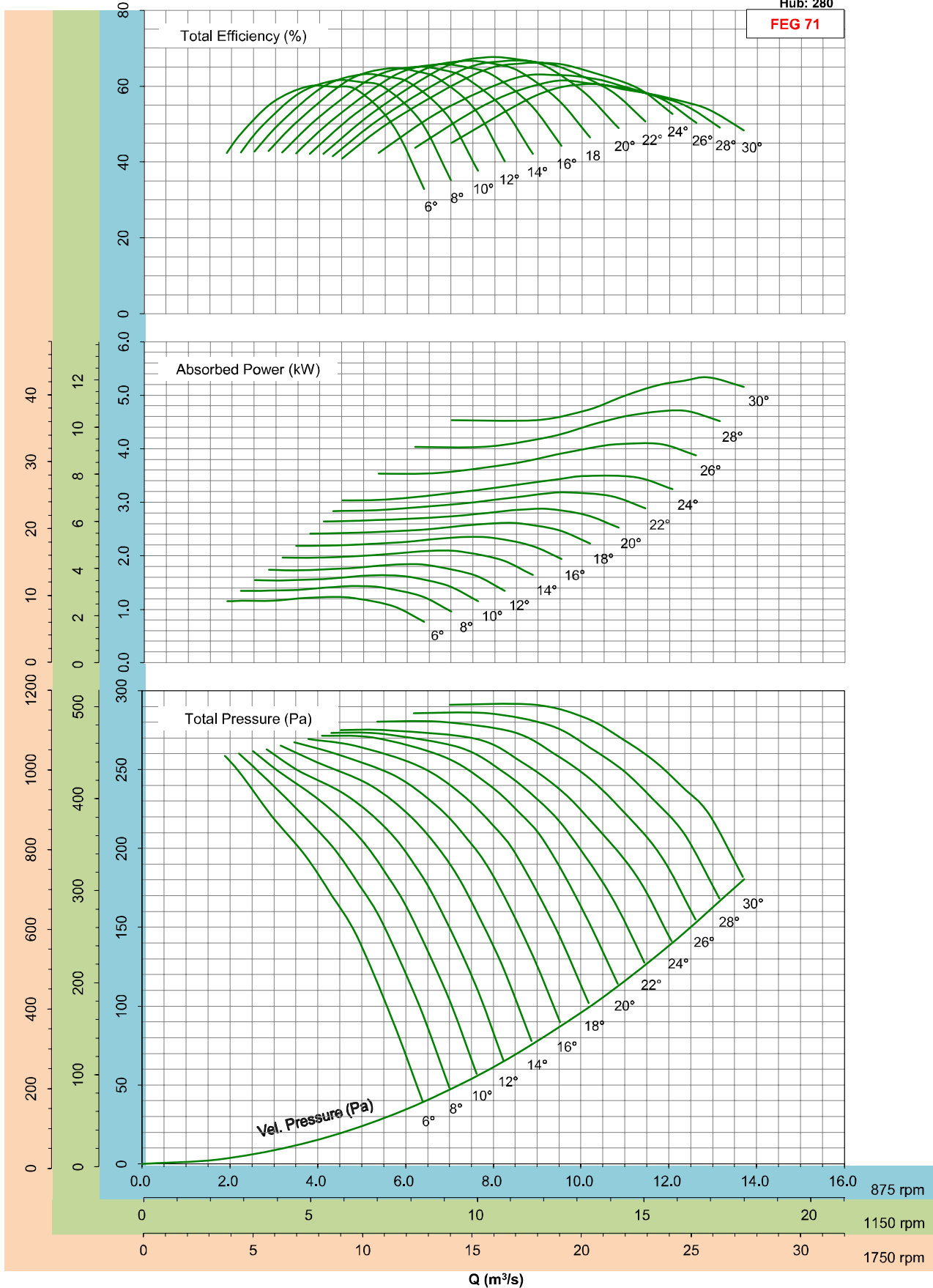

- Performance certified is for installation type D - ducted inlet, ducted outlet. Performance ratings do not include the effects of appurtenances (accessories).

- Please consult the nearest Kruger office for fan selection at 1750rpm.

TDA1000/20BH/8-8 60Hz



$\rho=1.2\text{kg/m}^3$
Hub: 280

FEG 71

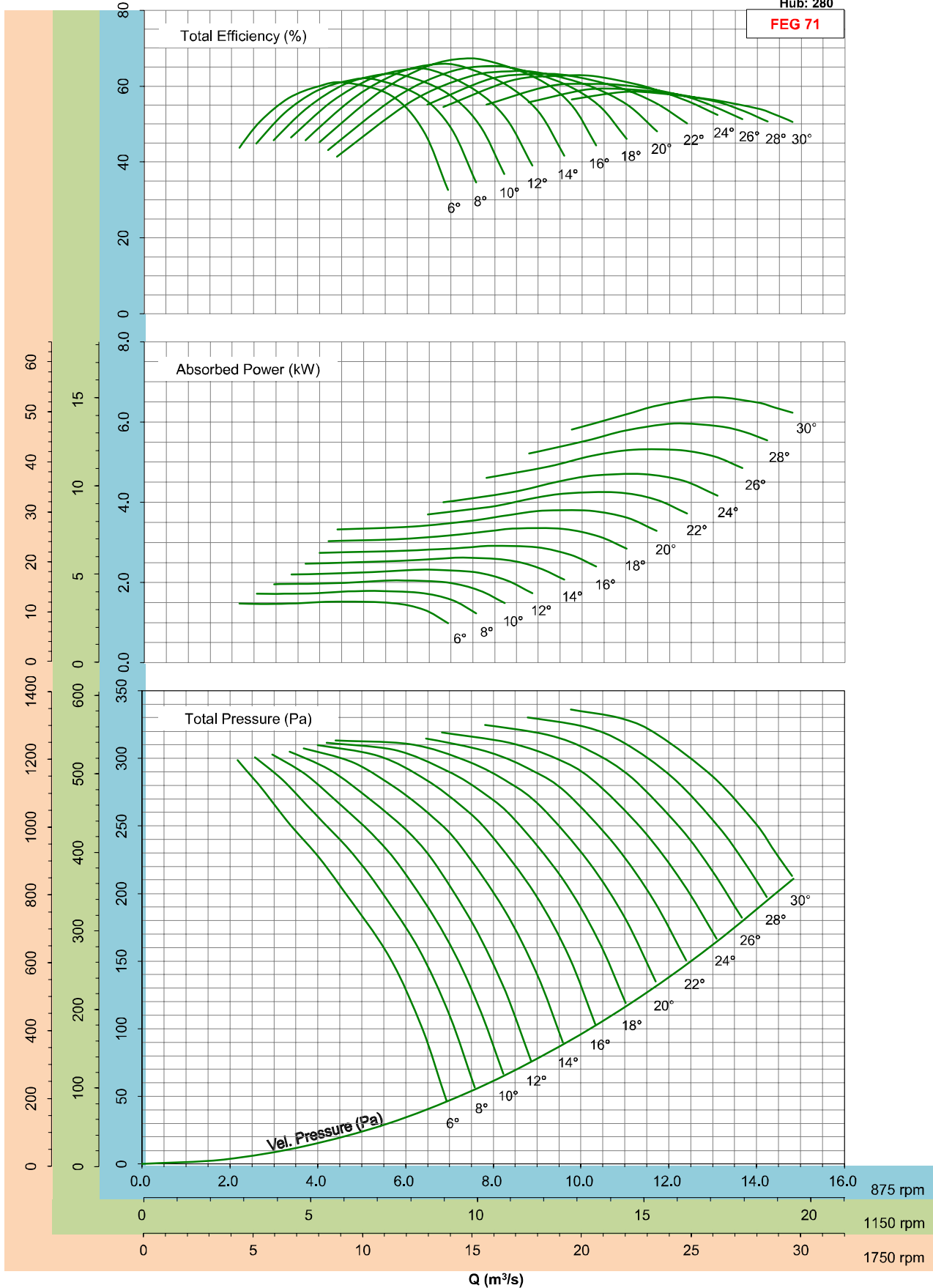

- Performance certified is for installation type D - ducted inlet, ducted outlet. Performance ratings do not include the effects of appurtenances (accessories).

- Please consult the nearest Kruger office for fan selection at 1750rpm.

TDA1120/14AA/6-12 60Hz



$\rho=1.2\text{kg/m}^3$
Hub: 280

FEG 75

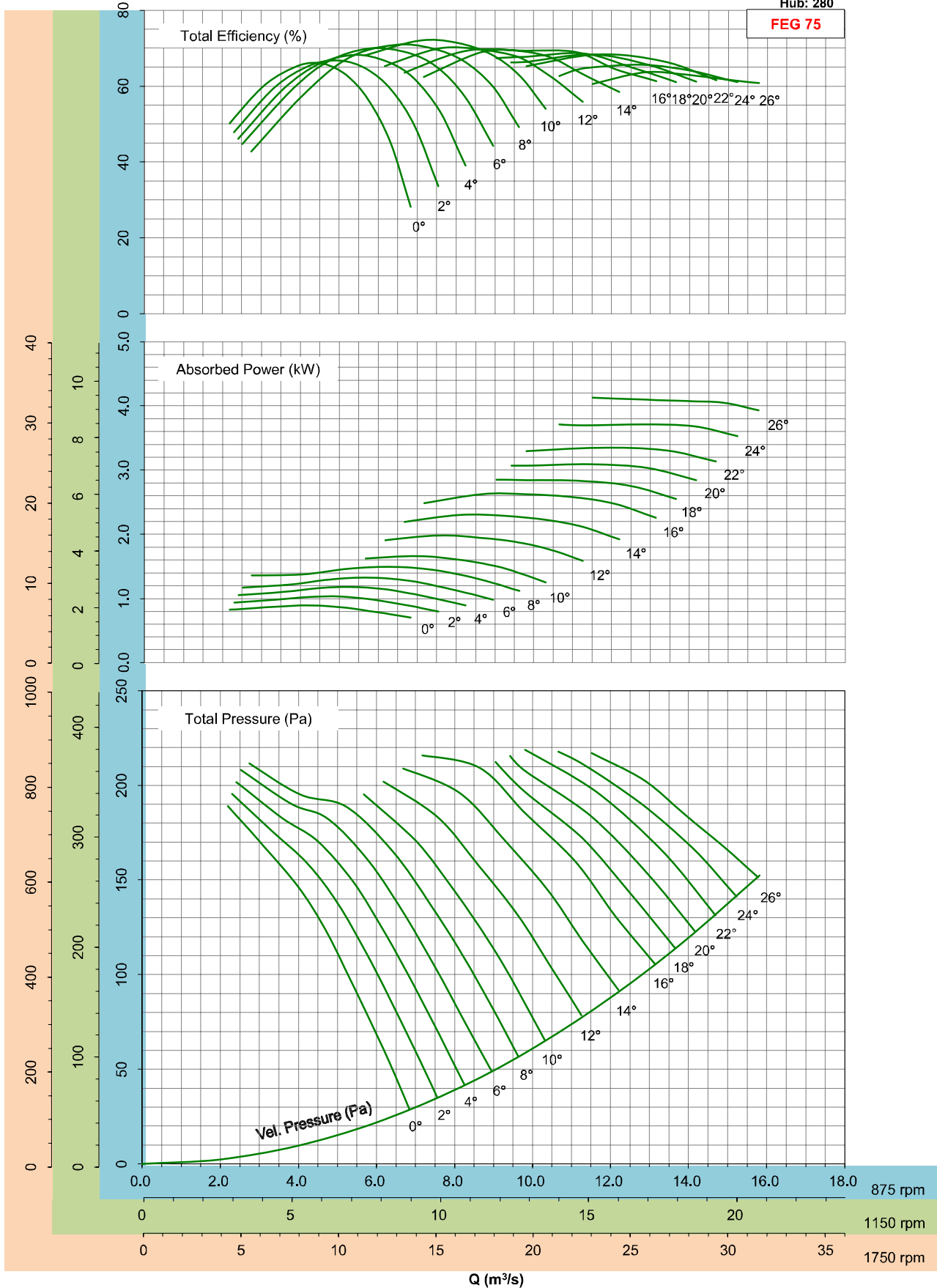

- Performance certified is for installation type D - ducted inlet, ducted outlet. Performance ratings do not include the effects of appurtenances (accessories).

- Please consult the nearest Kruger office for fan selection at 1750rpm.

TDA1120/14AA/8-8 60Hz



$\rho=1.2\text{kg/m}^3$
Hub: 266

FEG 75

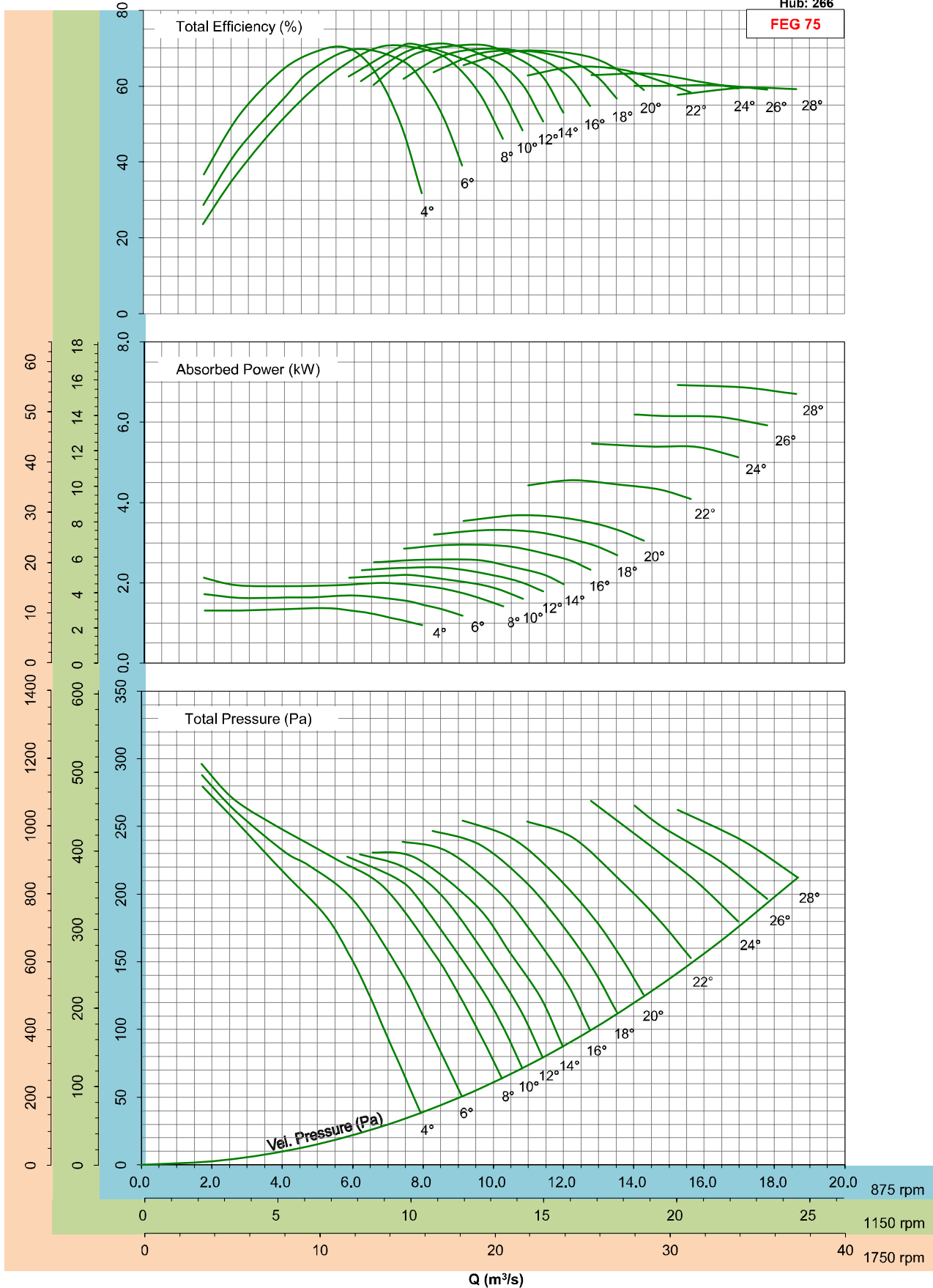

- Performance certified is for installation type D - ducted inlet, ducted outlet. Performance ratings do not include the effects of appurtenances (accessories).

- Please consult the nearest Kruger office for fan selection at 1750rpm.

TDA1120/18BI/4-4 60Hz



$\rho=1.2\text{kg/m}^3$
Hub: 315

FEG 71

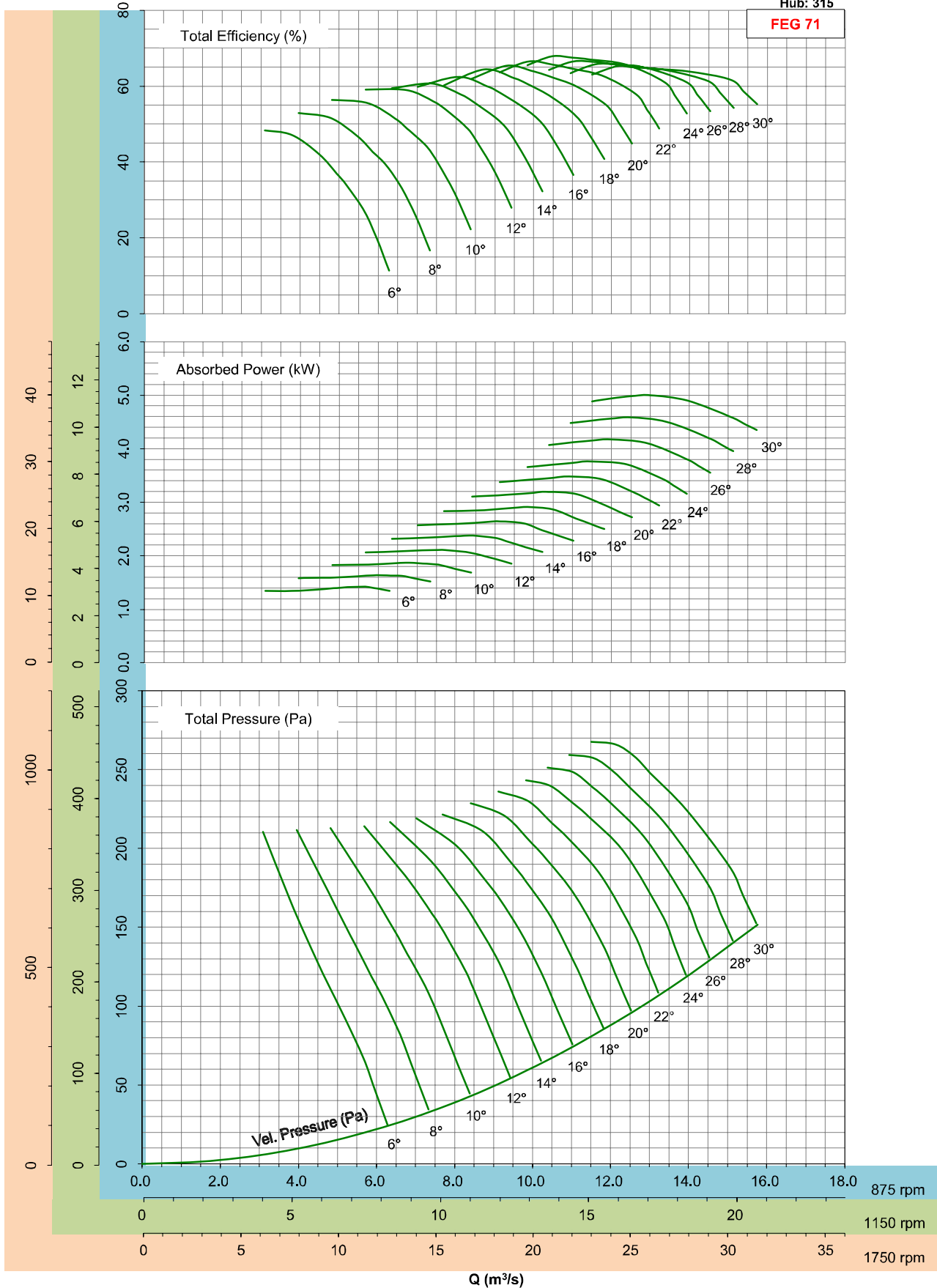

- Performance certified is for installation type D - ducted inlet, ducted outlet. Performance ratings do not include the effects of appurtenances (accessories).

- Please consult the nearest Kruger office for fan selection at 1750rpm.

TDA1120/18BI/6-6 60Hz



$\rho=1.2\text{kg/m}^3$
Hub: 315

FEG 71

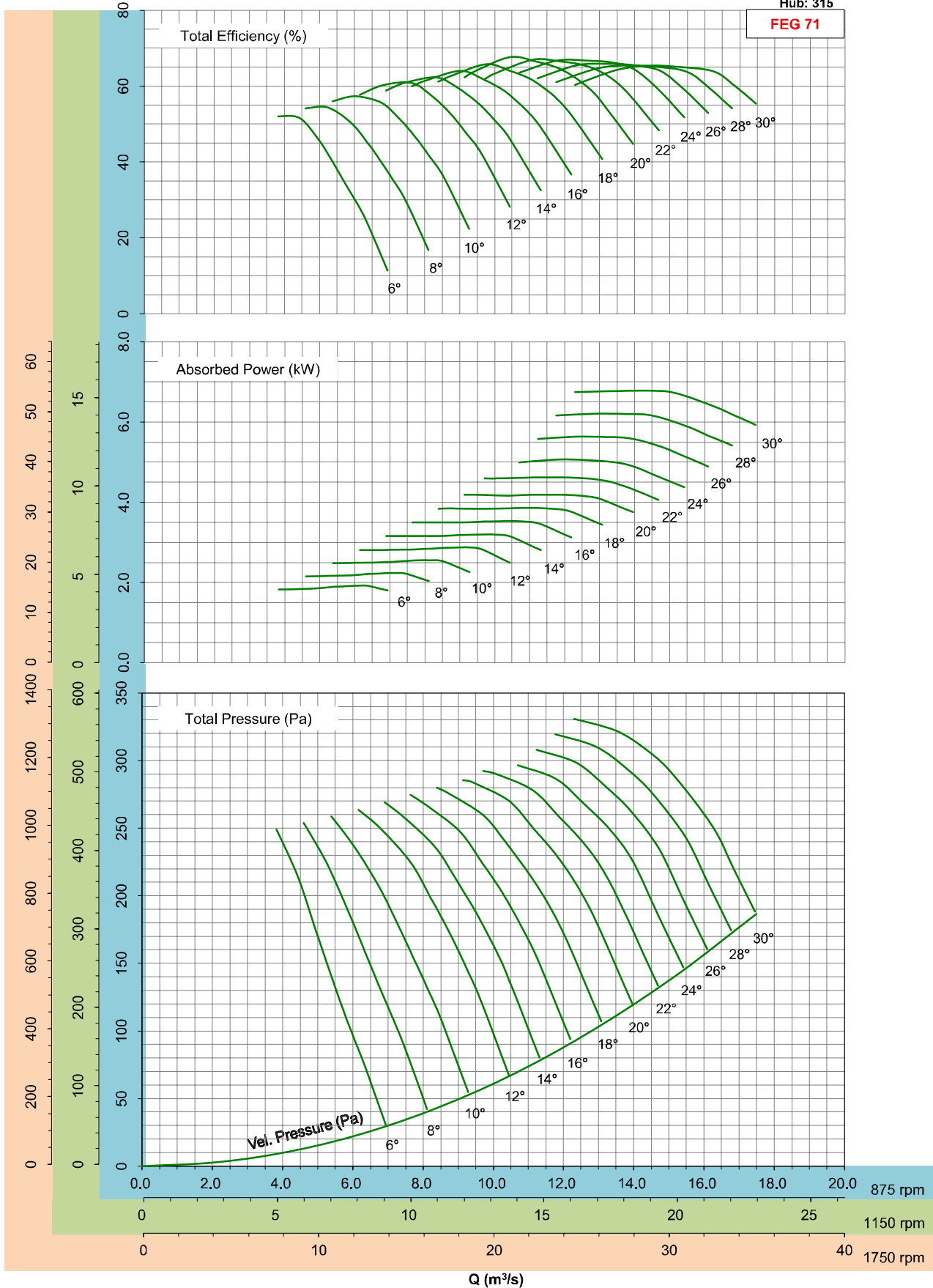

- Performance certified is for installation type D - ducted inlet, ducted outlet. Performance ratings do not include the effects of appurtenances (accessories).

- Please consult the nearest Kruger office for fan selection at 1750rpm.

TDA1120/18BI/8-8 60Hz



$\rho=1.2\text{kg/m}^3$
Hub: 315

FEG 71

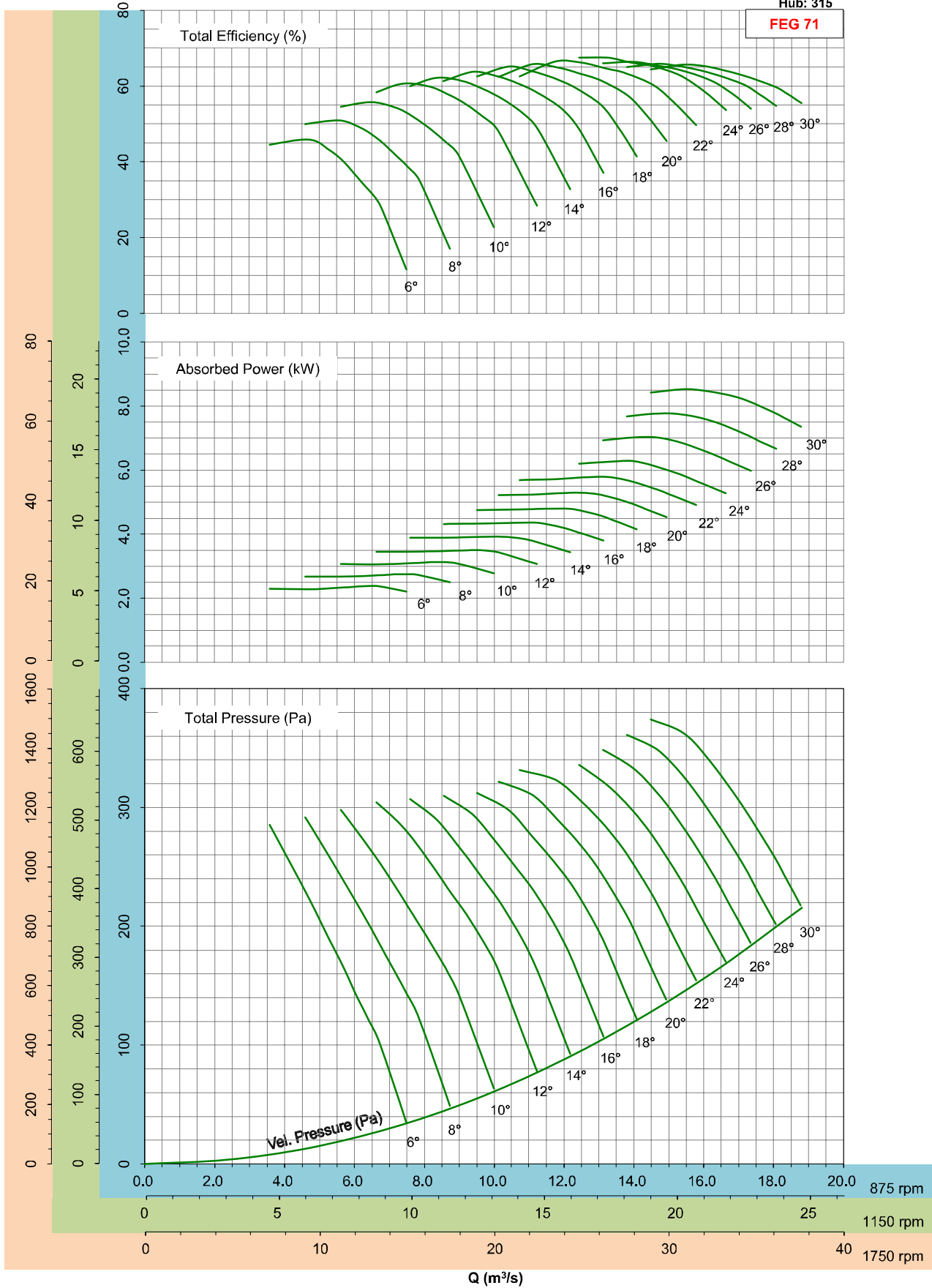

- Performance certified is for installation type D - ducted inlet, ducted outlet. Performance ratings do not include the effects of appurtenances (accessories).

- Please consult the nearest Kruger office for fan selection at 1750rpm.

TDA1120/20BI/4-4 60Hz



$\rho=1.2\text{kg/m}^3$
Hub: 315

FEG 71

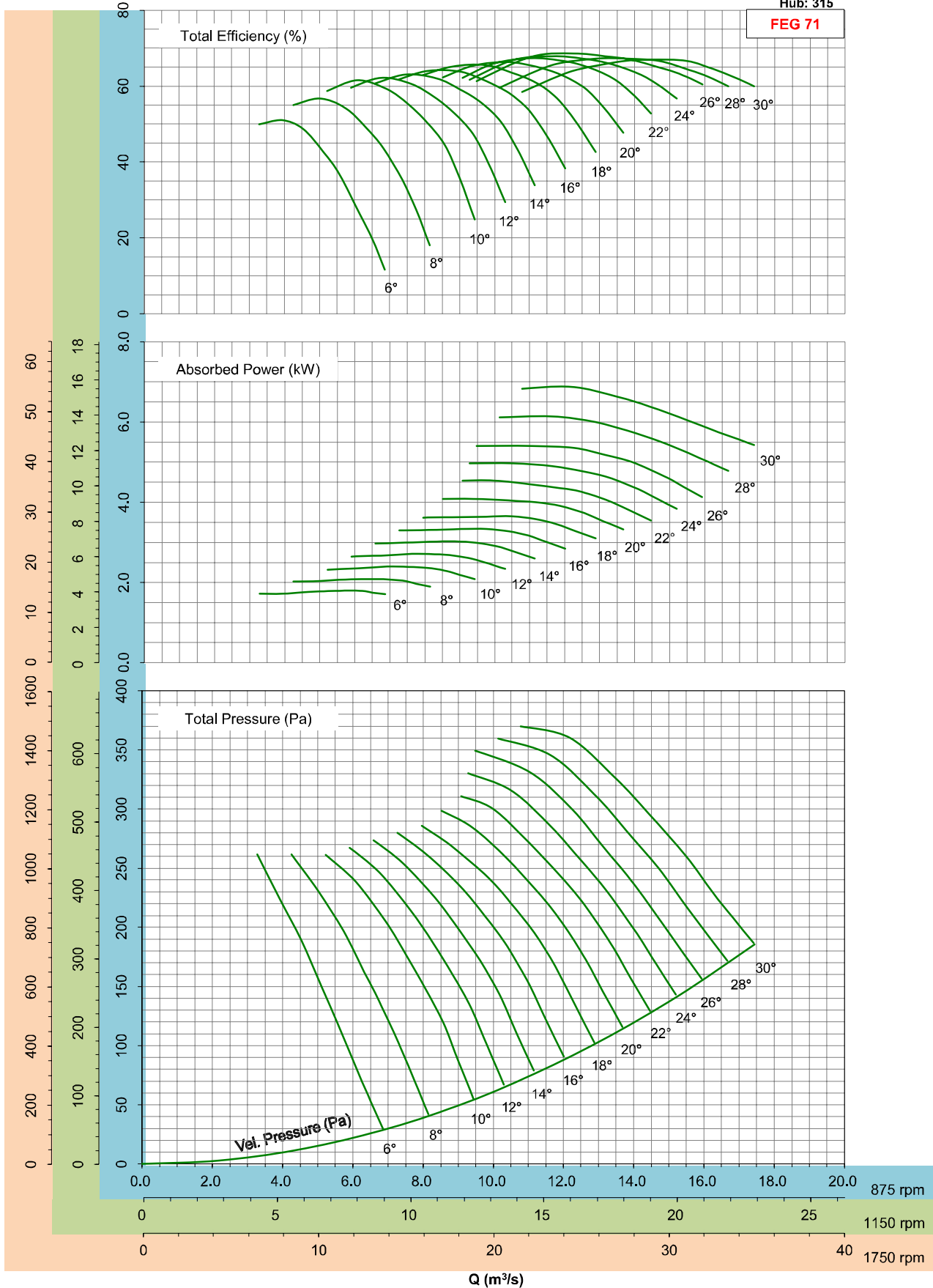

- Performance certified is for installation type D - ducted inlet, ducted outlet. Performance ratings do not include the effects of appurtenances (accessories).

- Please consult the nearest Kruger office for fan selection at 1750rpm.

TDA1120/20BI/6-6 60Hz



$\rho=1.2\text{kg/m}^3$
Hub: 315

FEG 71

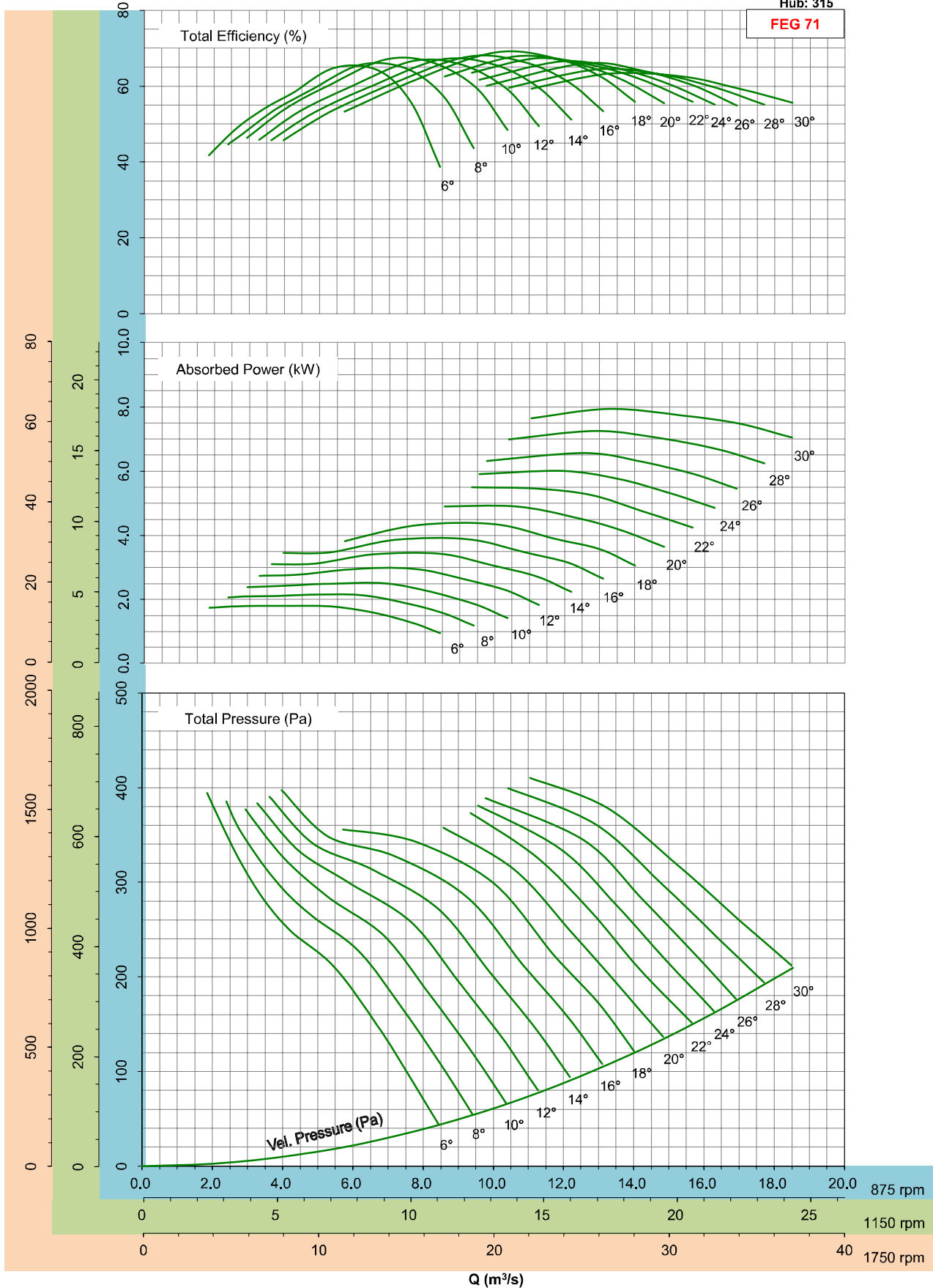

- Performance certified is for installation type D - ducted inlet, ducted outlet. Performance ratings do not include the effects of appurtenances (accessories).

- Please consult the nearest Kruger office for fan selection at 1750rpm.

TDA1120/20BI/8-8 60Hz



$\rho=1.2\text{kg/m}^3$
Hub: 315

FEG 71

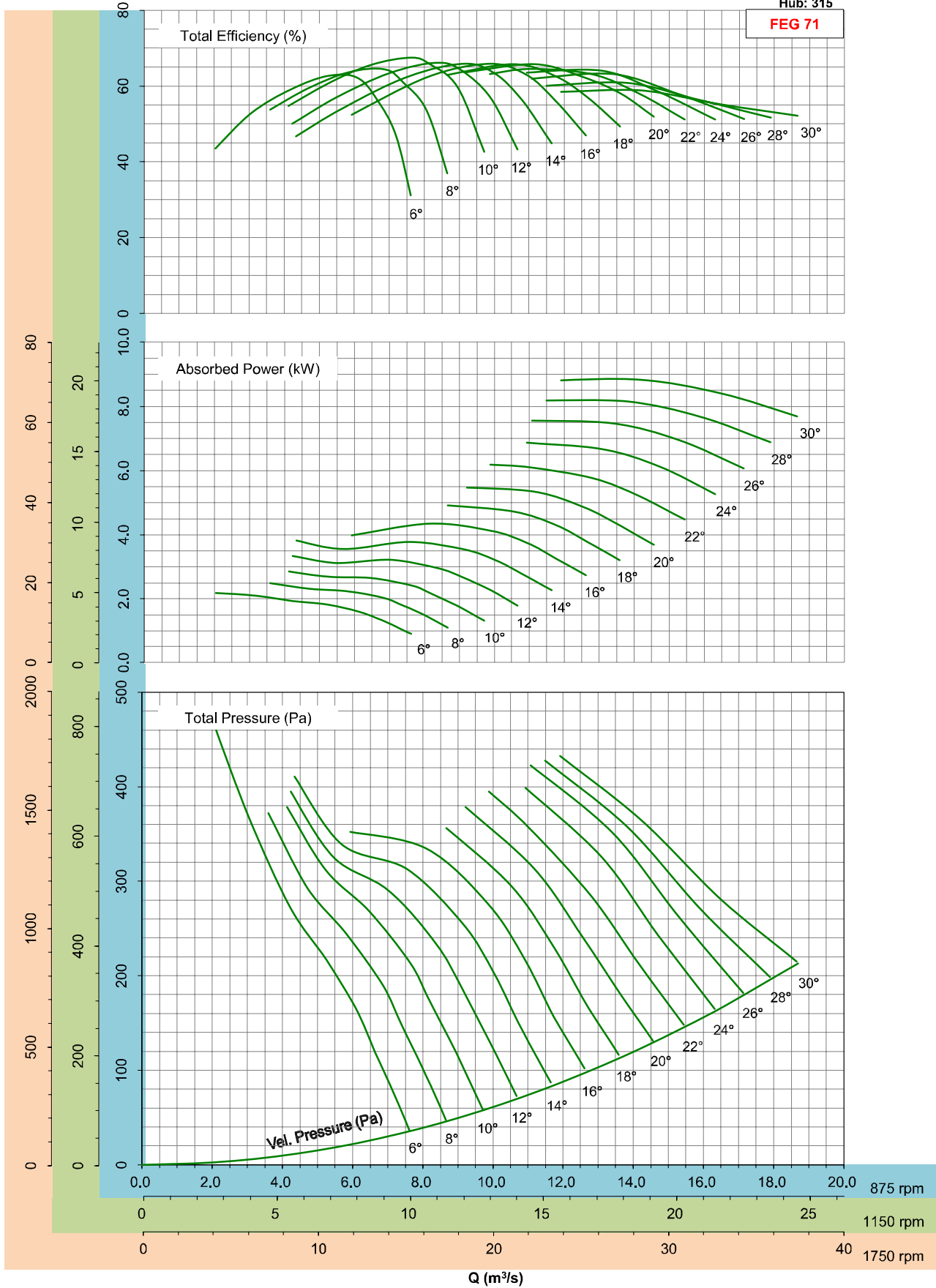

- Performance certified is for installation type D - ducted inlet, ducted outlet. Performance ratings do not include the effects of appurtenances (accessories).

- Please consult the nearest Kruger office for fan selection at 1750rpm.

TDA1250/20BJ/4-4 60Hz



$\rho=1.2\text{kg/m}^3$
Hub: 353

FEG 71

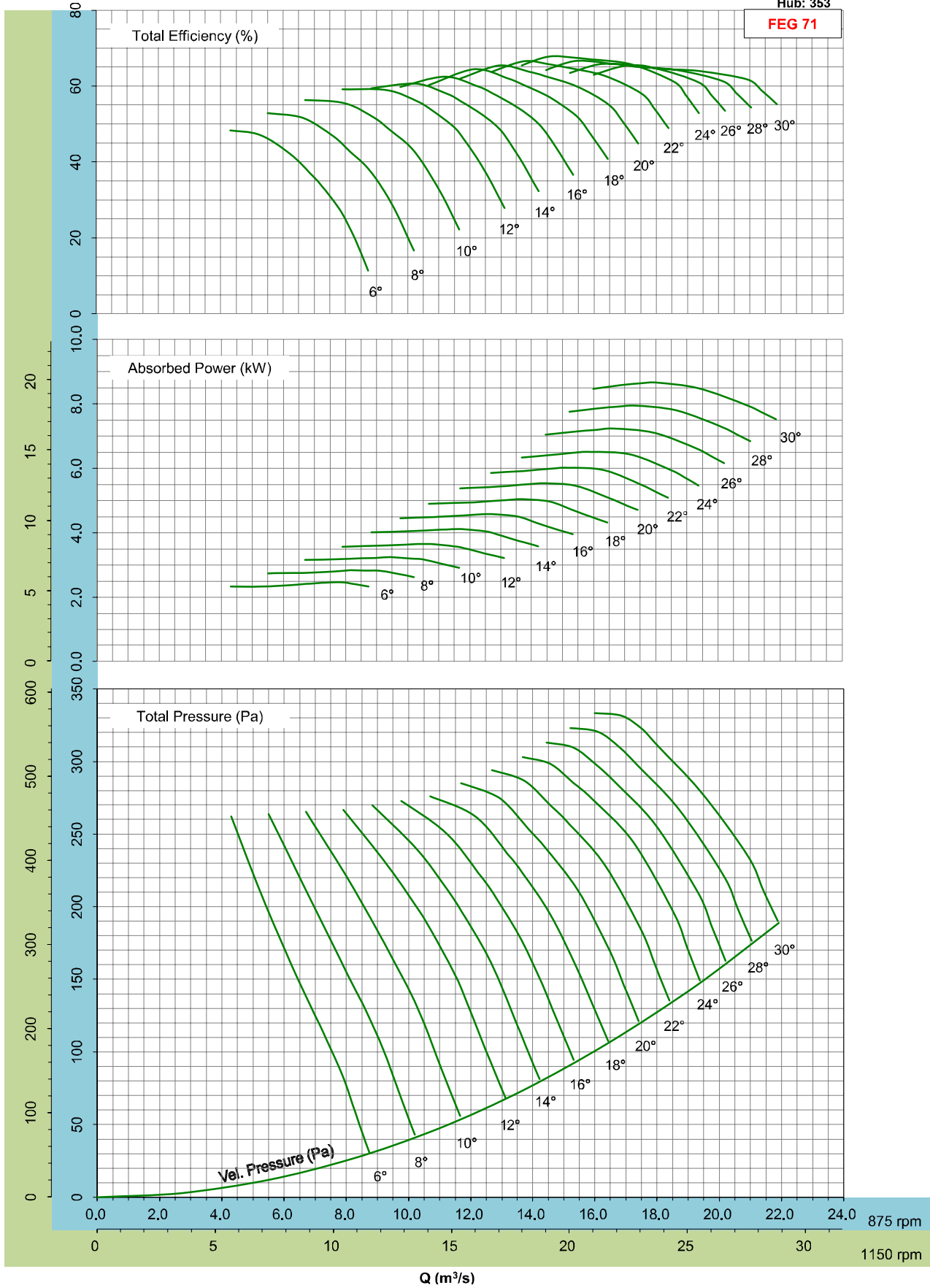

- Performance certified for installation type D - ducted inlet, ducted outlet. Performance ratings do not include the effects of appurtenances (accessories).

TDA1250/20BJ/6-6 60Hz



$\rho=1.2\text{kg/m}^3$
Hub: 353

FEG 71

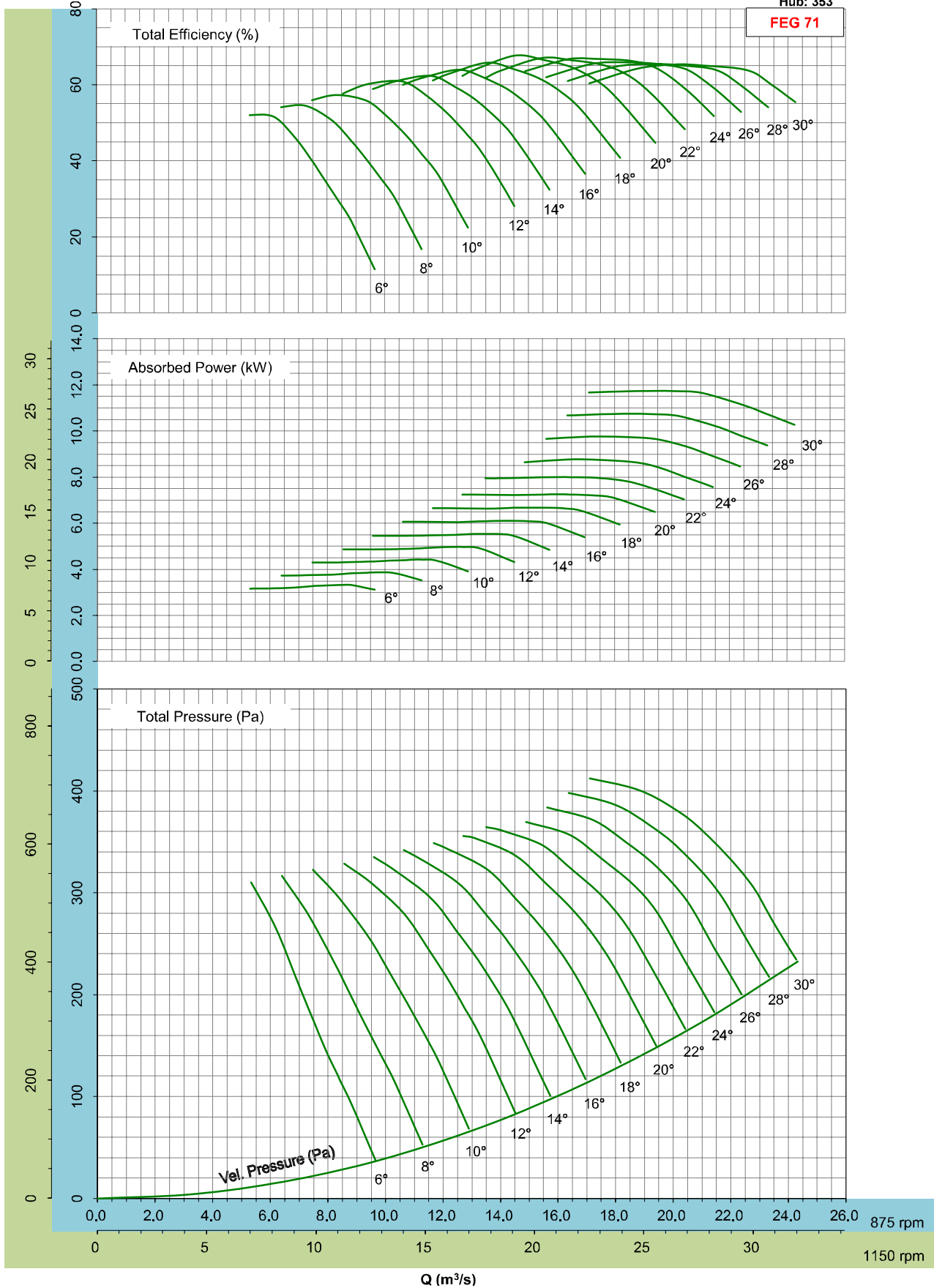

- Performance certified for installation type D - ducted inlet, ducted outlet. Performance ratings do not include the effects of appurtenances (accessories).

TDA1250/20BJ/8-8 60Hz



$\rho=1.2\text{kg/m}^3$
Hub: 353

FEG 71

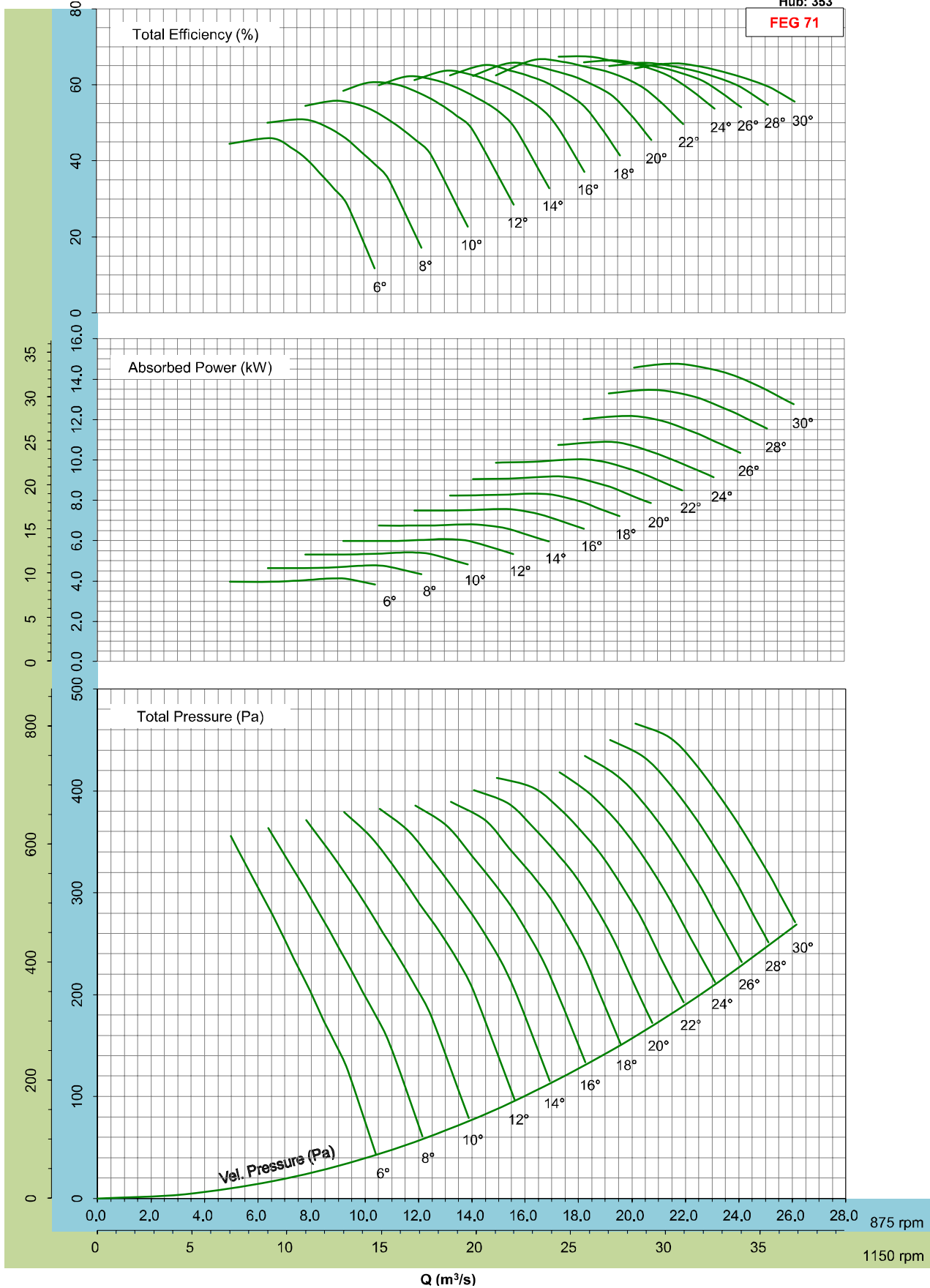

- Performance certified is for installation type D - ducted inlet, ducted outlet. Performance ratings do not include the effects of appurtenances (accessories).

TDA1250/25BJ/4-4 60Hz



$\rho=1.2\text{kg/m}^3$
Hub: 353

FEG 71

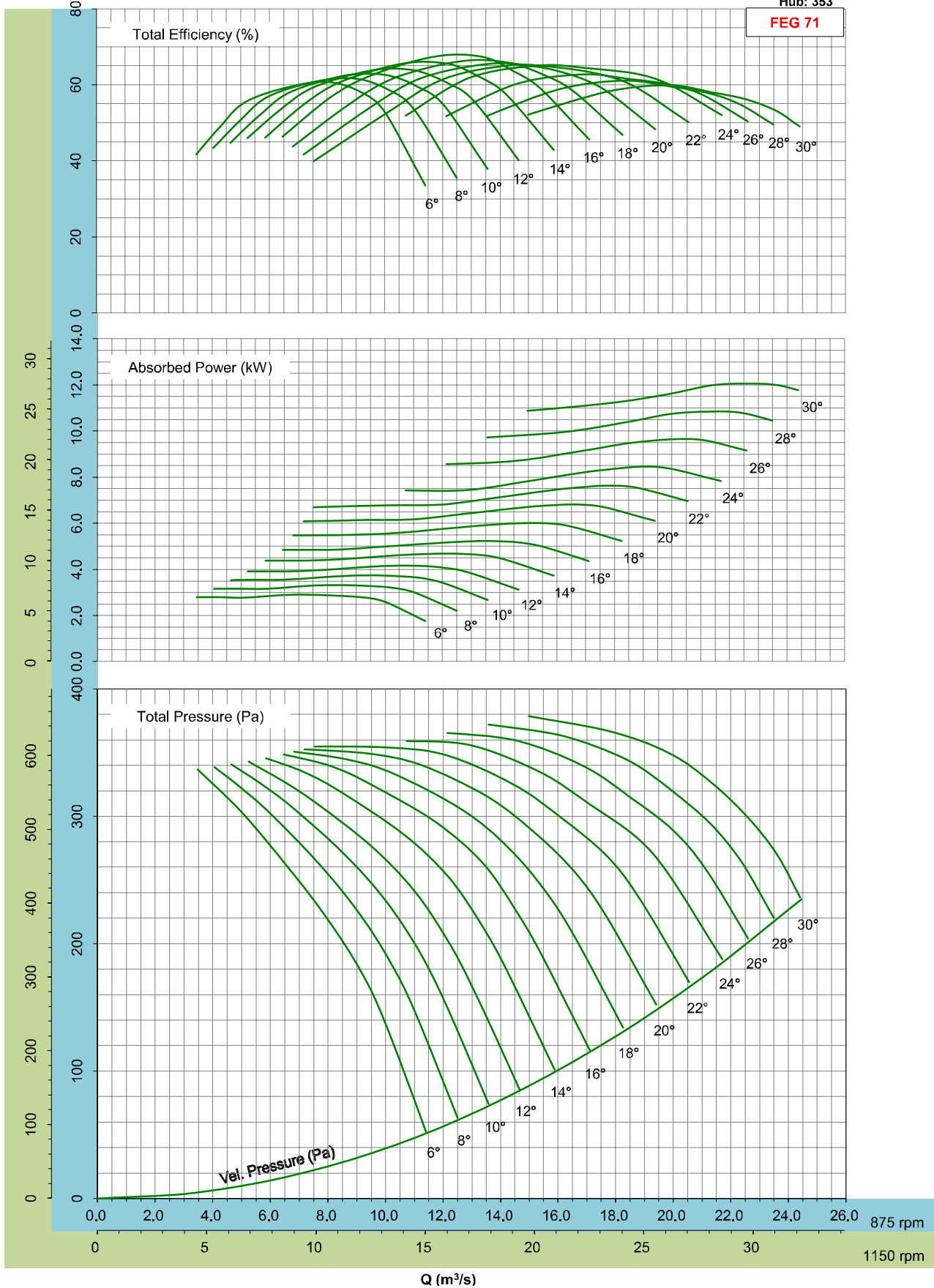

- Performance certified for installation type D - ducted inlet, ducted outlet. Performance ratings do not include the effects of appurtenances (accessories).

TDA1250/25BJ/6-6 60Hz



$\rho=1.2\text{kg/m}^3$
Hub: 353

FEG 71

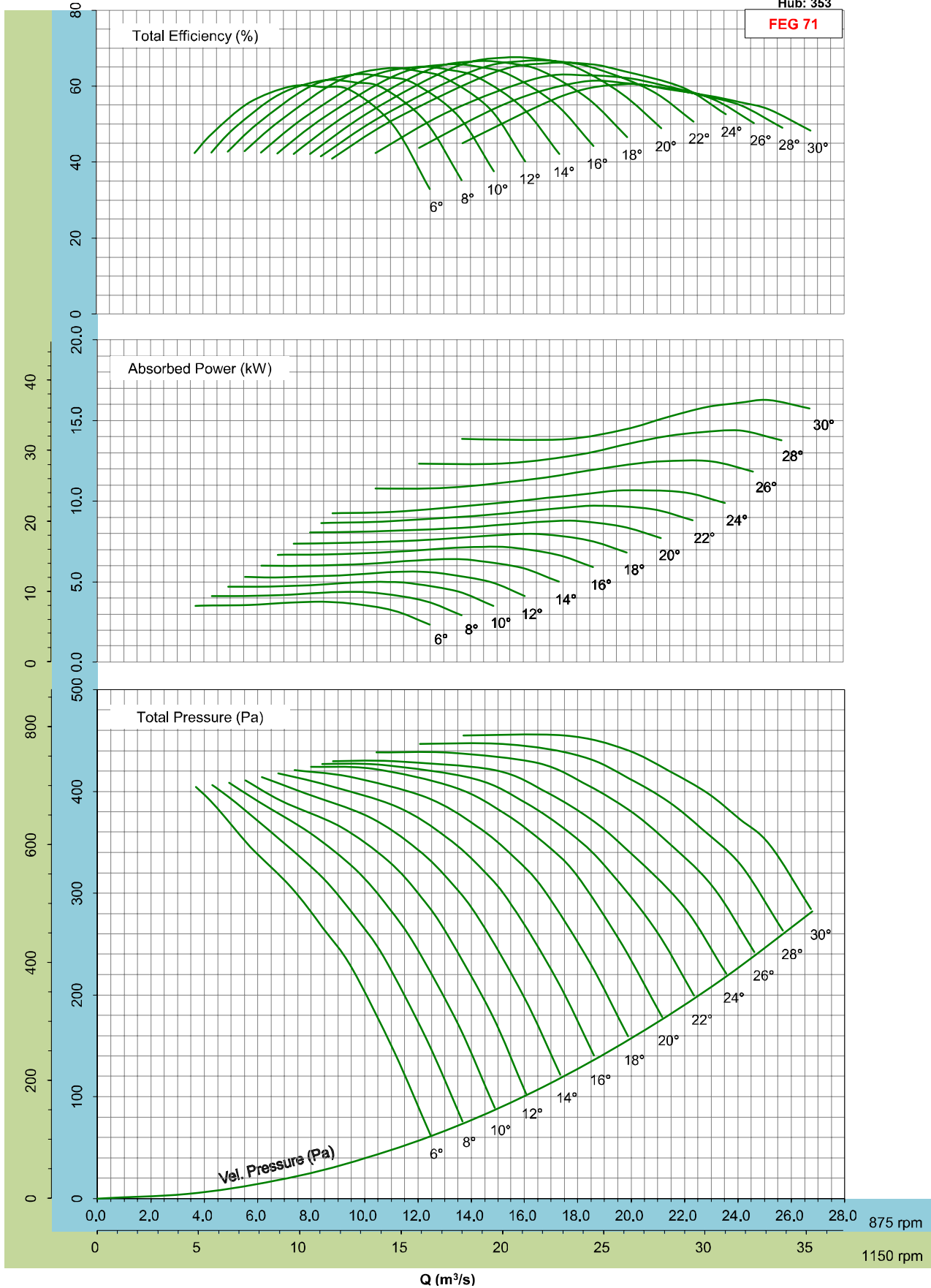

- Performance certified for installation type D - ducted inlet, ducted outlet. Performance ratings do not include the effects of appurtenances (accessories).

TDA1250/25BJ/8-8 60Hz



$\rho=1.2\text{kg/m}^3$
Hub: 353

FEG 71

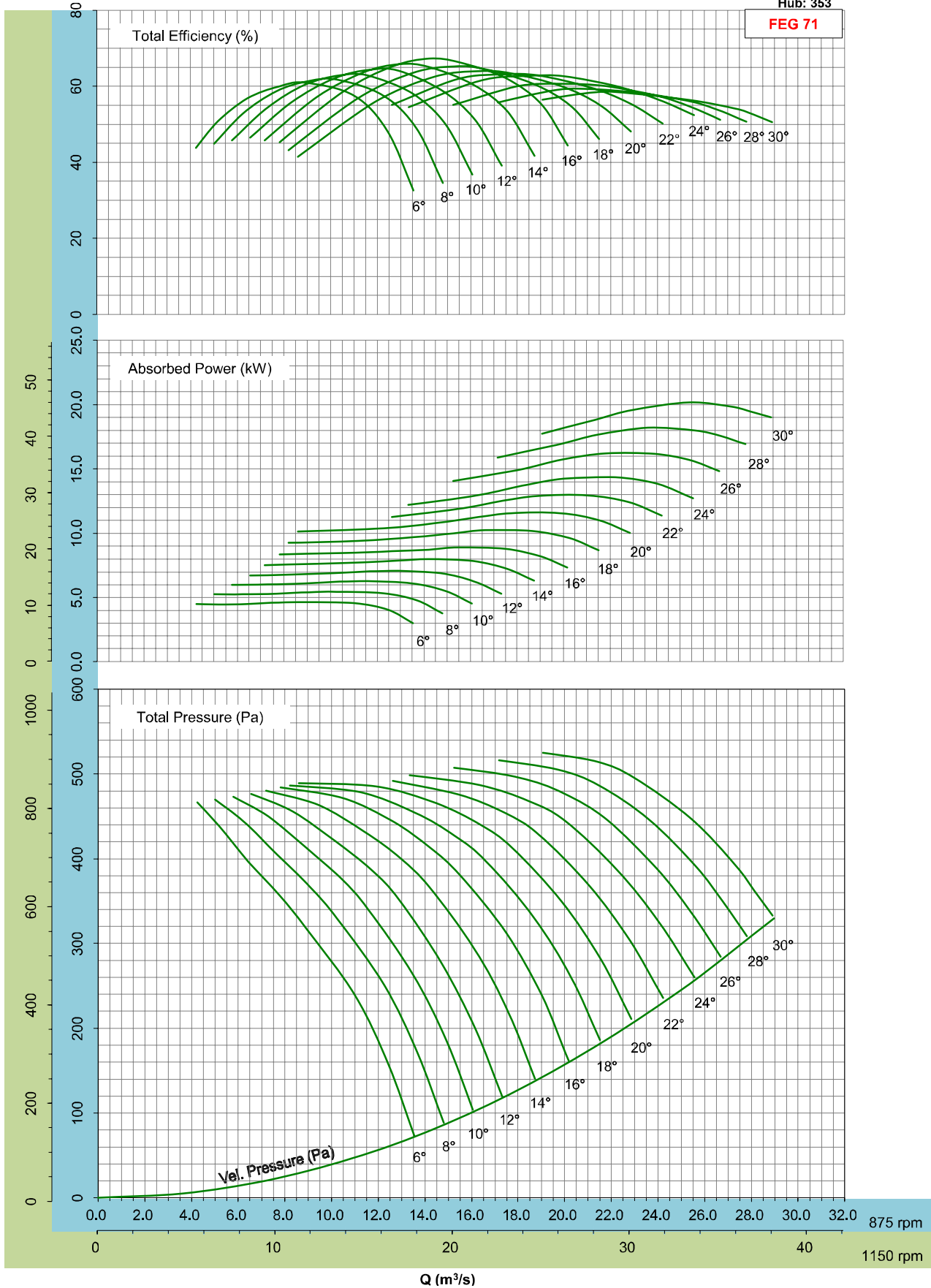

- Performance certified for installation type D - ducted inlet, ducted outlet. Performance ratings do not include the effects of appurtenances (accessories).

TDA1400/25BK/4-4 60Hz



$\rho=1.2\text{kg/m}^3$
Hub: 397

FEG 71

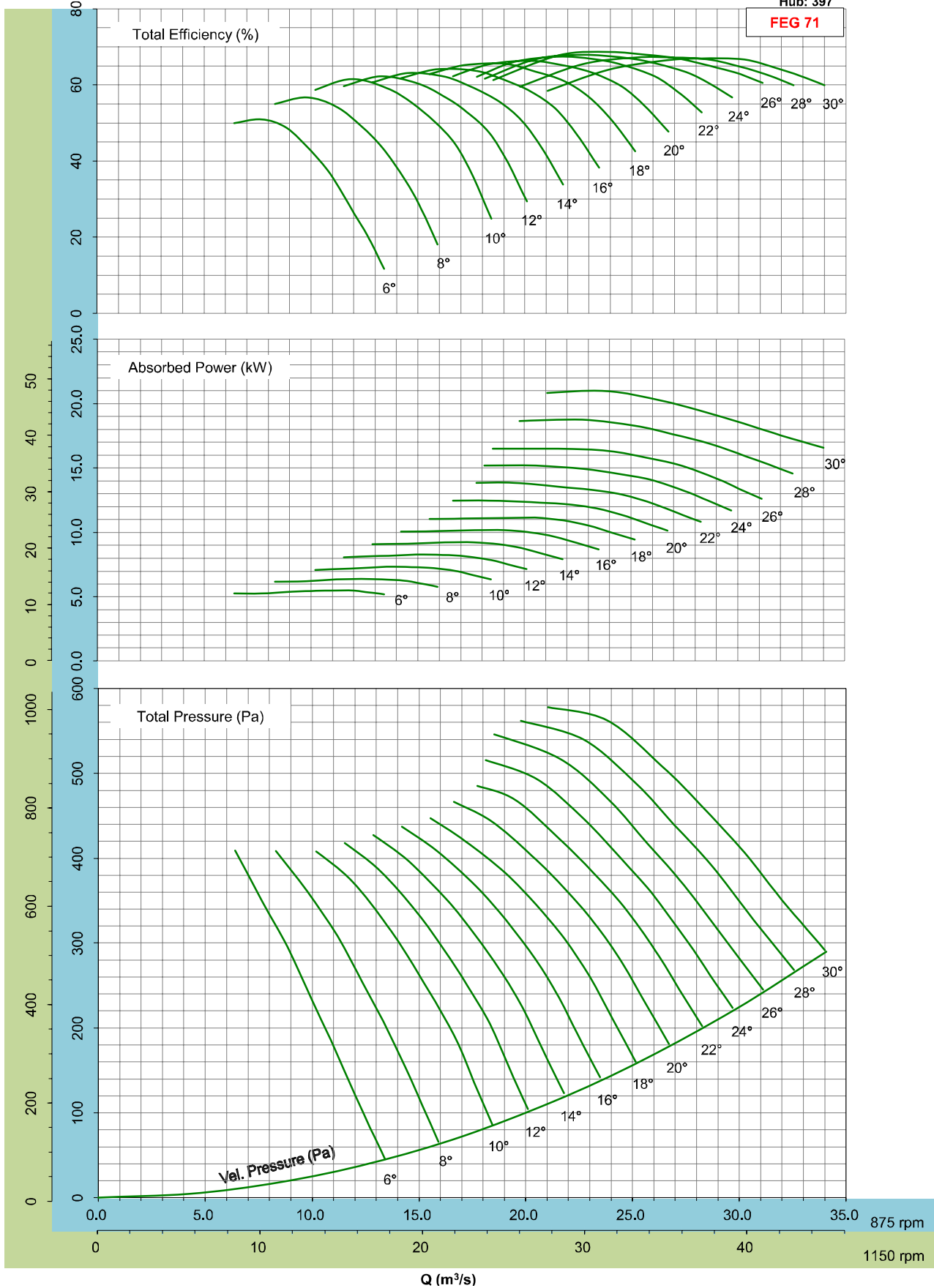

- Performance certified for installation type D - ducted inlet, ducted outlet. Performance ratings do not include the effects of appurtenances (accessories).

TDA1400/25BK/6-6 60Hz



$\rho=1.2\text{kg/m}^3$
Hub: 397

FEG 71

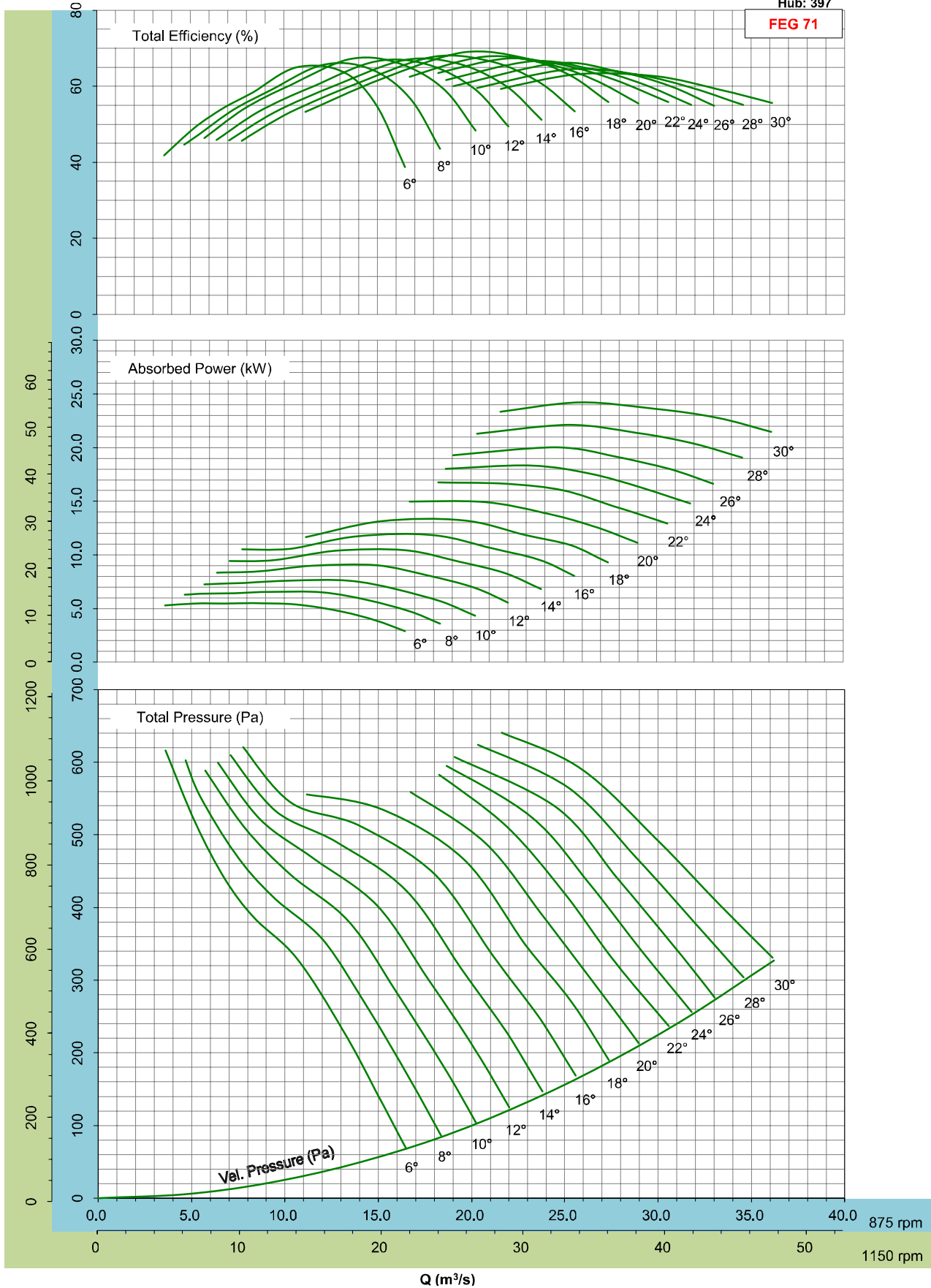

- Performance certified for installation type D - ducted inlet, ducted outlet. Performance ratings do not include the effects of appurtenances (accessories).

TDA1400/25BK/8-8 60Hz



$\rho=1.2\text{kg/m}^3$
Hub: 397

FEG 71

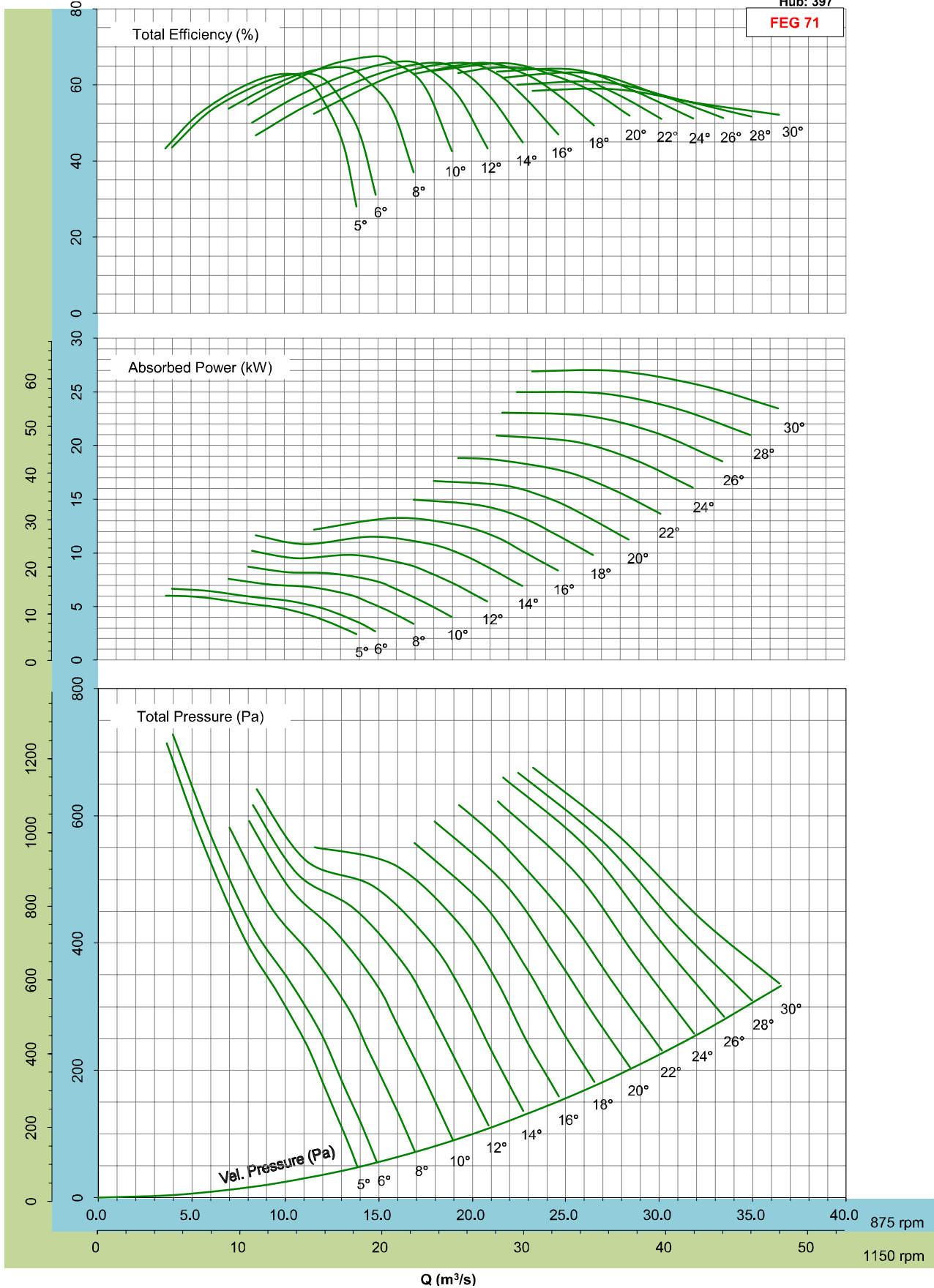

- Performance certified for installation type D - ducted inlet, ducted outlet. Performance ratings do not include the effects of appurtenances (accessories).

TDA1600/25BL/4-4 60Hz



$\rho=1.2\text{kg/m}^3$
Hub: 450

FEG 71

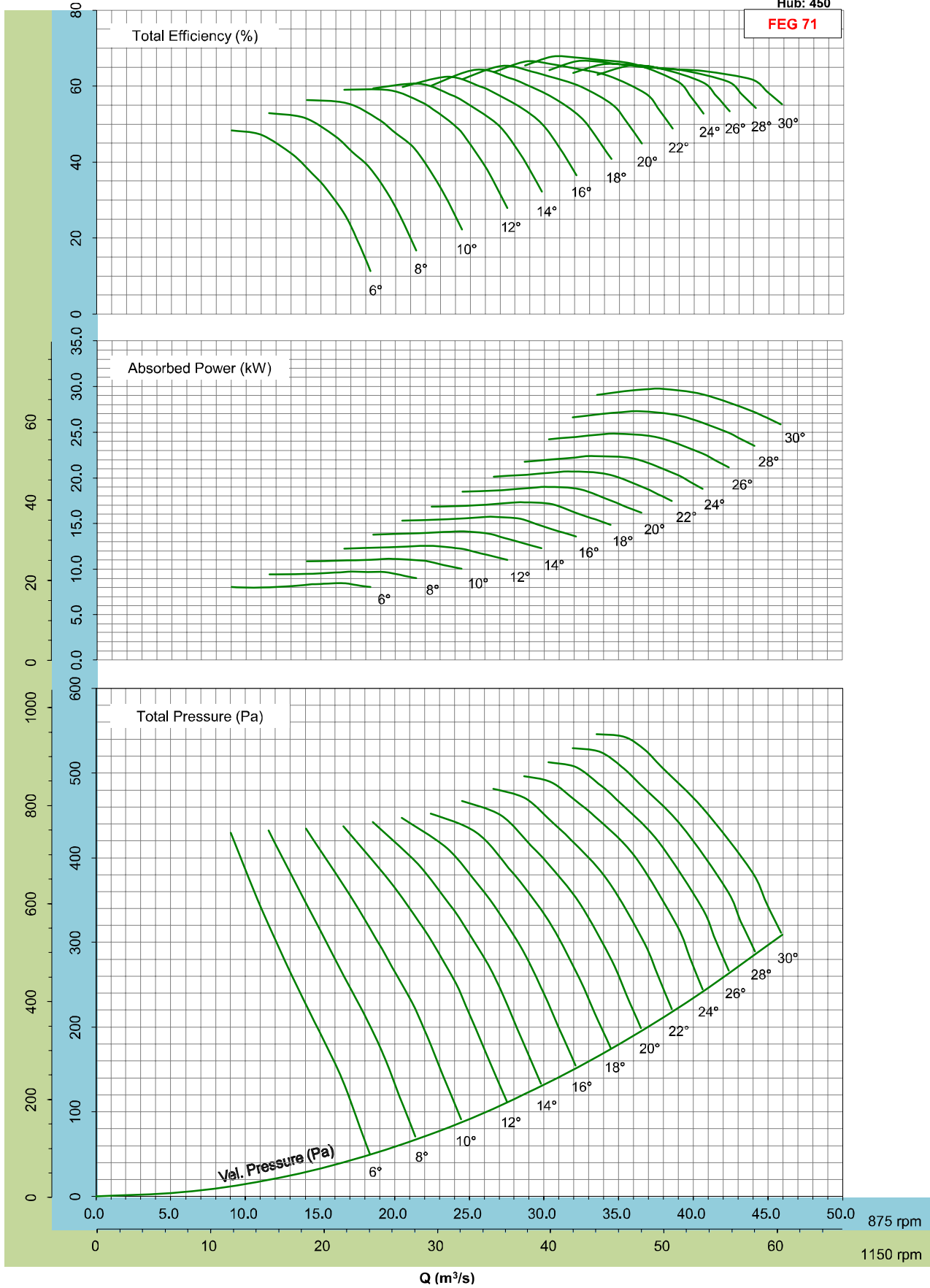

- Performance certified is for installation type D - ducted inlet, ducted outlet. Performance ratings do not include the effects of appurtenances (accessories).

- Please consult the nearest Kruger office for fan selection at 1750rpm.

TDA1600/25BL/6-6 60Hz



$\rho=1.2\text{kg/m}^3$
Hub: 450

FEG 71

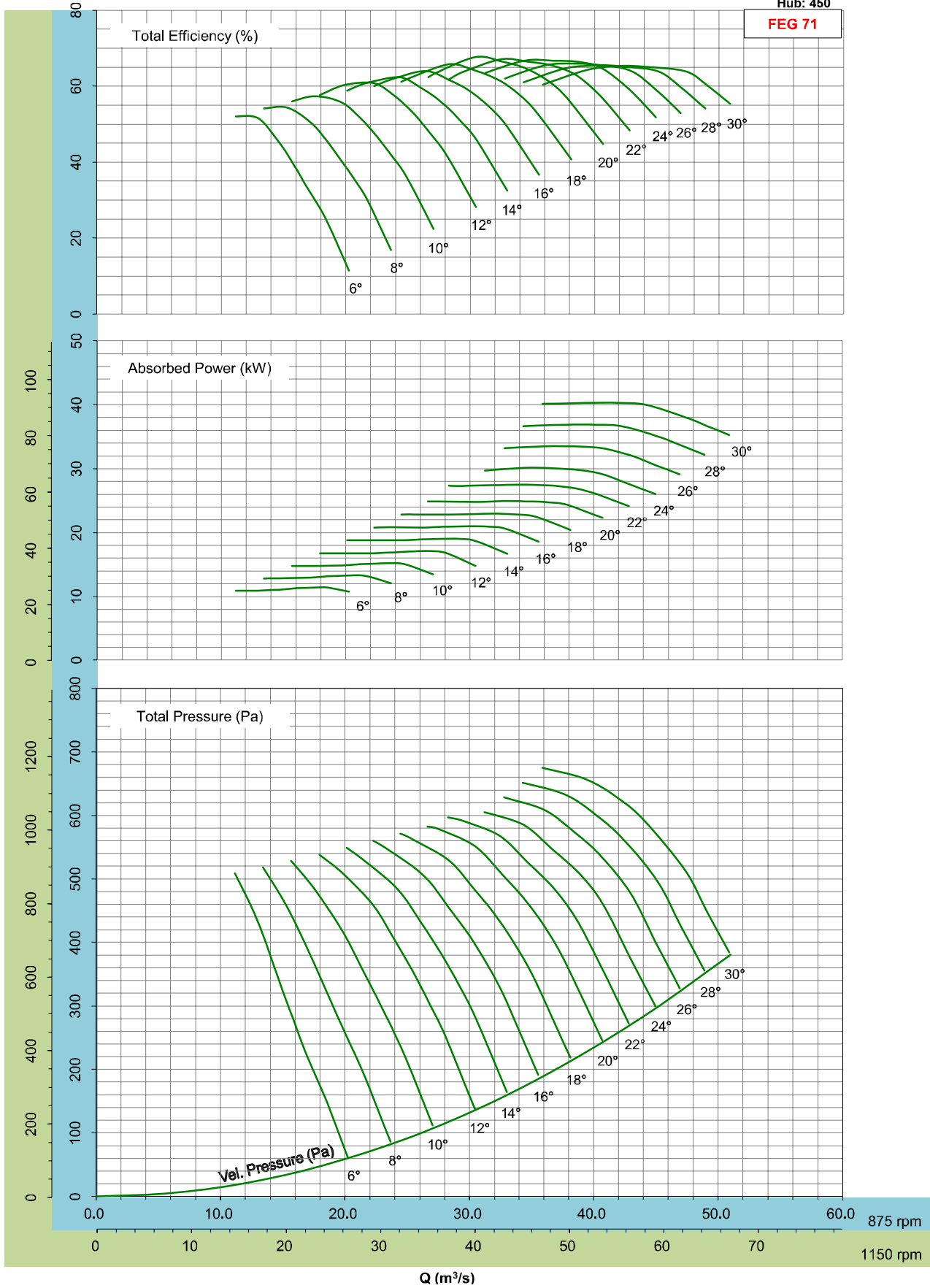

- Performance certified is for installation type D - ducted inlet, ducted outlet. Performance ratings do not include the effects of appurtenances (accessories).

- Please consult the nearest Kruger office for fan selection at 1750rpm.

TDA1600/25BL/8-8 60Hz



$\rho=1.2\text{kg/m}^3$
Hub: 450

FEG 71

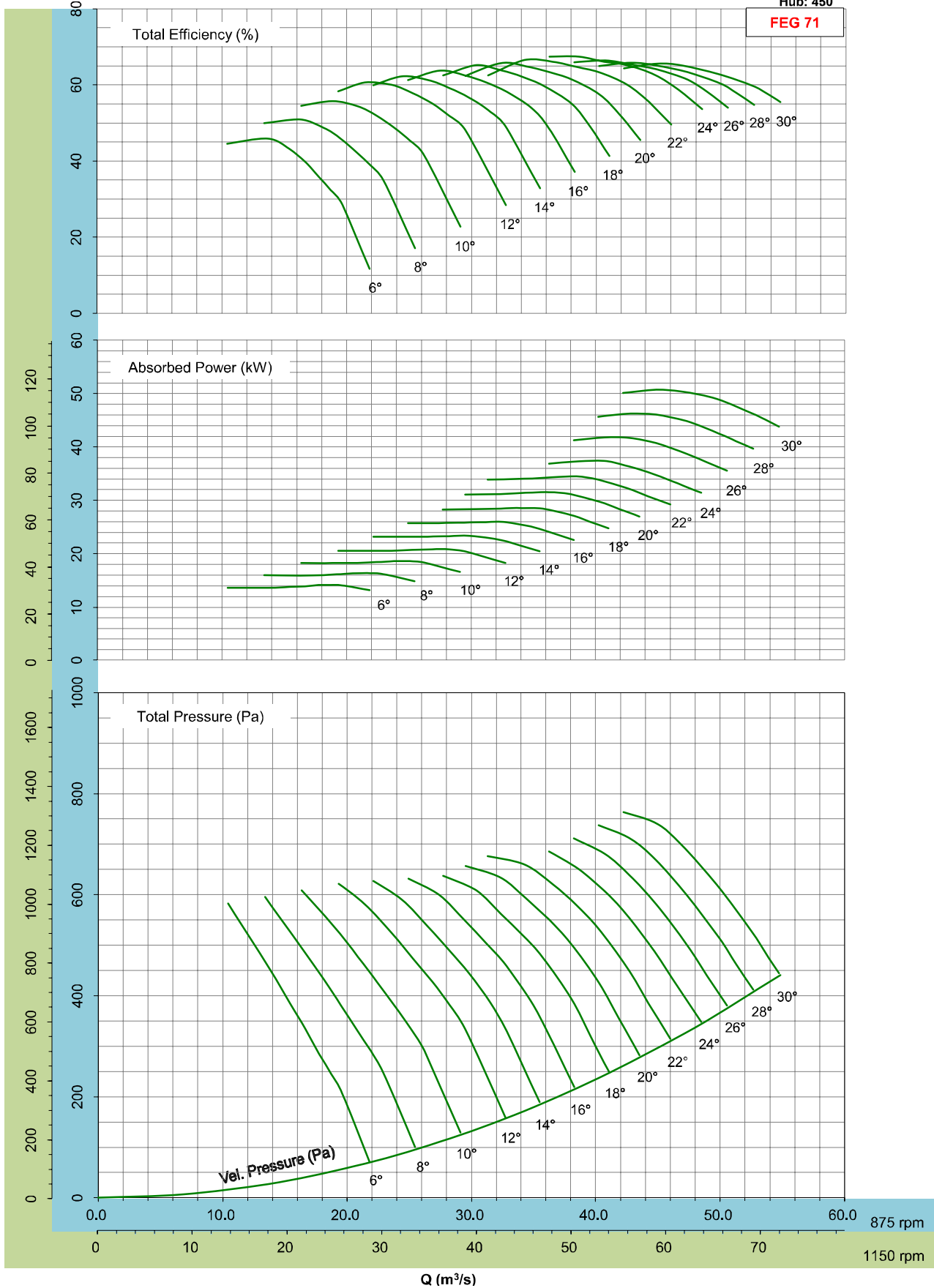

- Performance certified is for installation type D - ducted inlet, ducted outlet. Performance ratings do not include the effects of appurtenances (accessories).

- Please consult the nearest Kruger office for fan selection at 1750rpm.

TDA1600/31BL/4-4 60Hz



$\rho=1.2\text{kg/m}^3$
Hub: 450

FEG 71

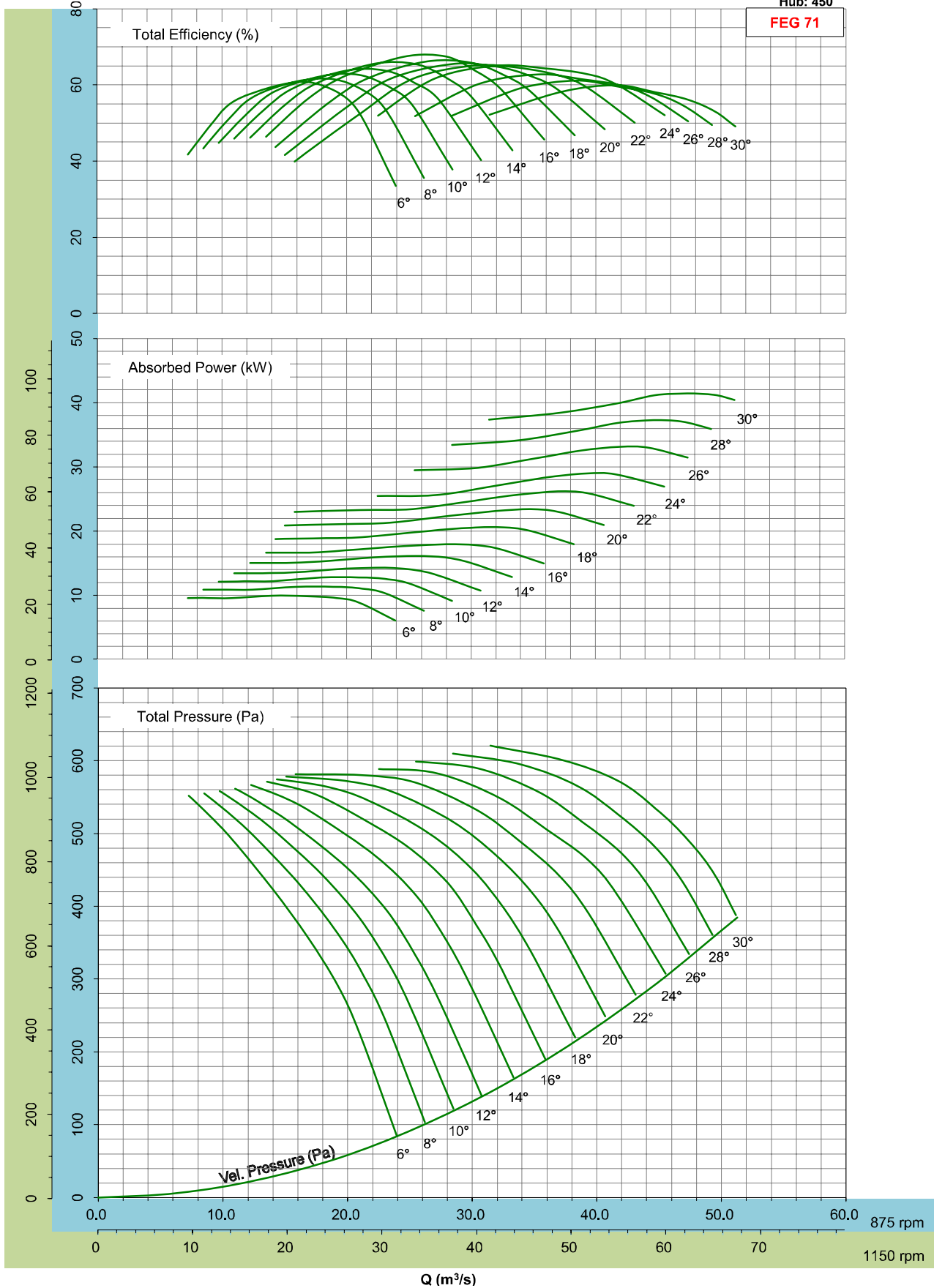

- Performance certified is for installation type D - ducted inlet, ducted outlet. Performance ratings do not include the effects of appurtenances (accessories).

- Please consult the nearest Kruger office for fan selection at 1750rpm.

TDA1600/31BL/6-6 60Hz



$\rho=1.2\text{kg/m}^3$
Hub: 450

FEG 71

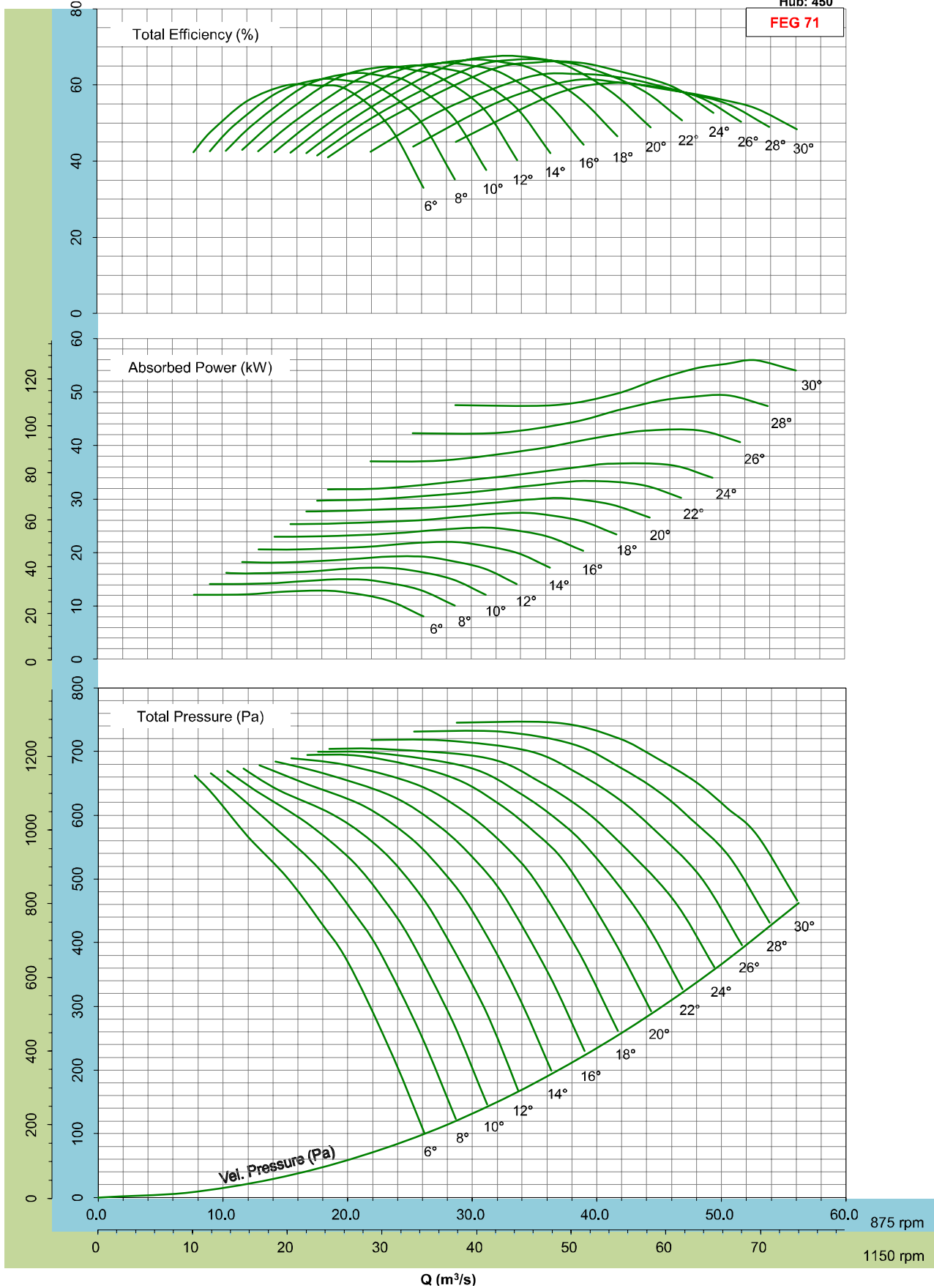

- Performance certified is for installation type D - ducted inlet, ducted outlet. Performance ratings do not include the effects of appurtenances (accessories).

- Please consult the nearest Kruger office for fan selection at 1750rpm.

TDA1600/31BL/8-8 60Hz



$\rho=1.2\text{kg/m}^3$
Hub: 450

FEG 71

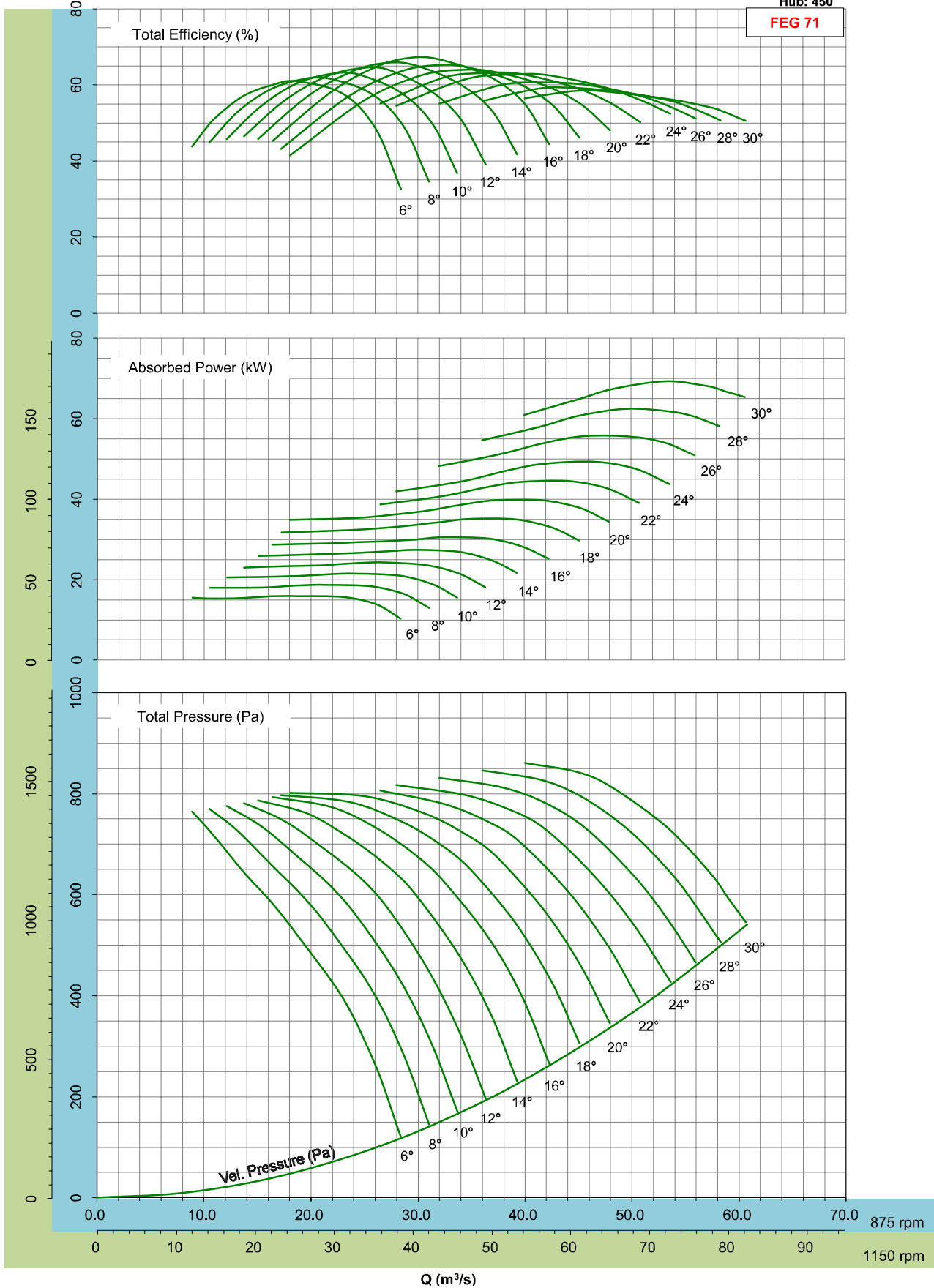

- Performance certified is for installation type D - ducted inlet, ducted outlet. Performance ratings do not include the effects of appurtenances (accessories).

- Please consult the nearest Kruger office for fan selection at 1750rpm.

TDA1800/31BM/4-4 60Hz



$\rho=1.2\text{kg/m}^3$
Hub: 502

FEG 71

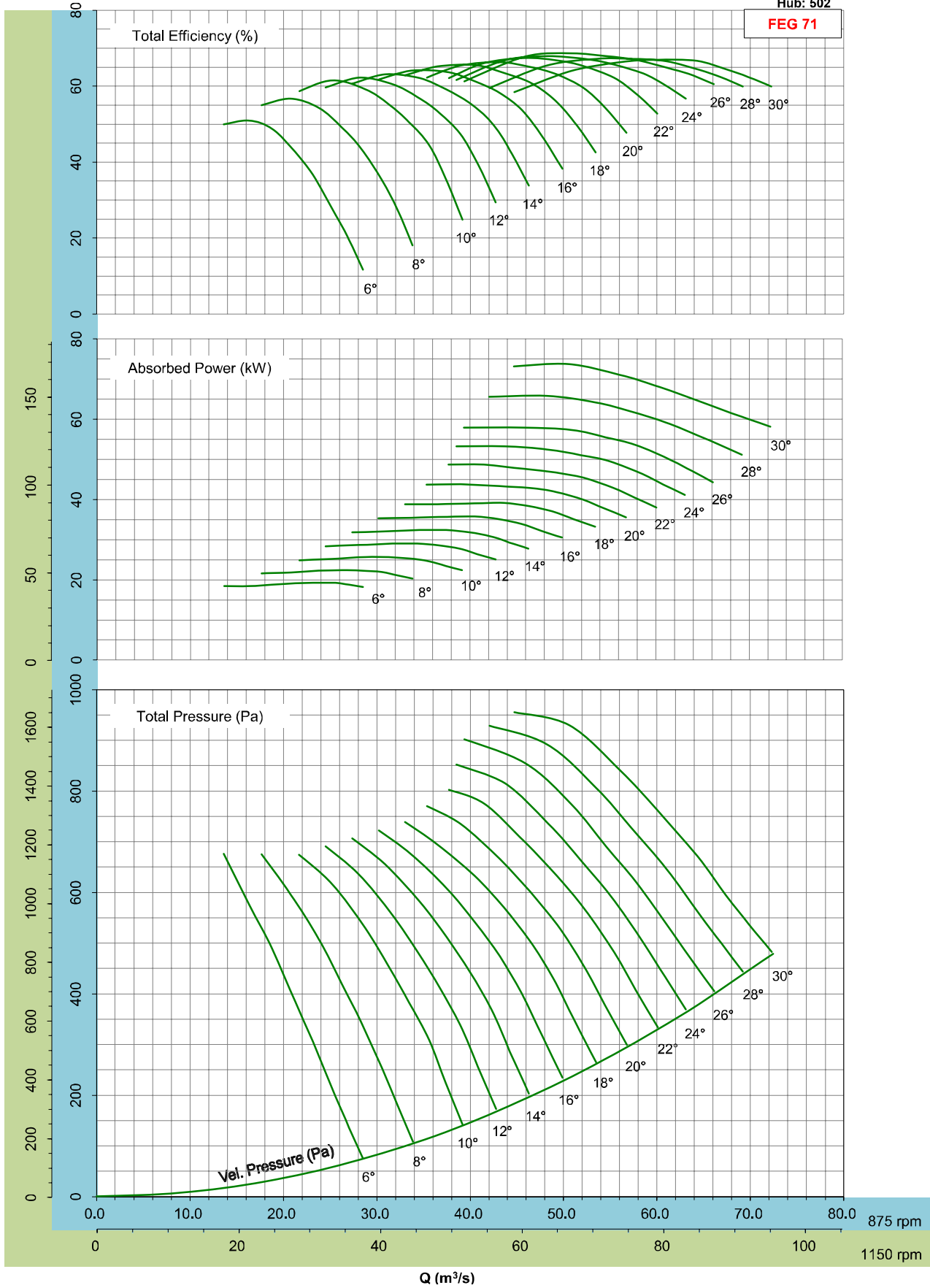

- Performance certified is for installation type D - ducted inlet, ducted outlet. Performance ratings do not include the effects of appurtenances (accessories).

- Please consult the nearest Kruger office for fan selection at 1750rpm.

TDA1800/31BM/6-6 60Hz



$\rho=1.2\text{kg/m}^3$
Hub: 502

FEG 71

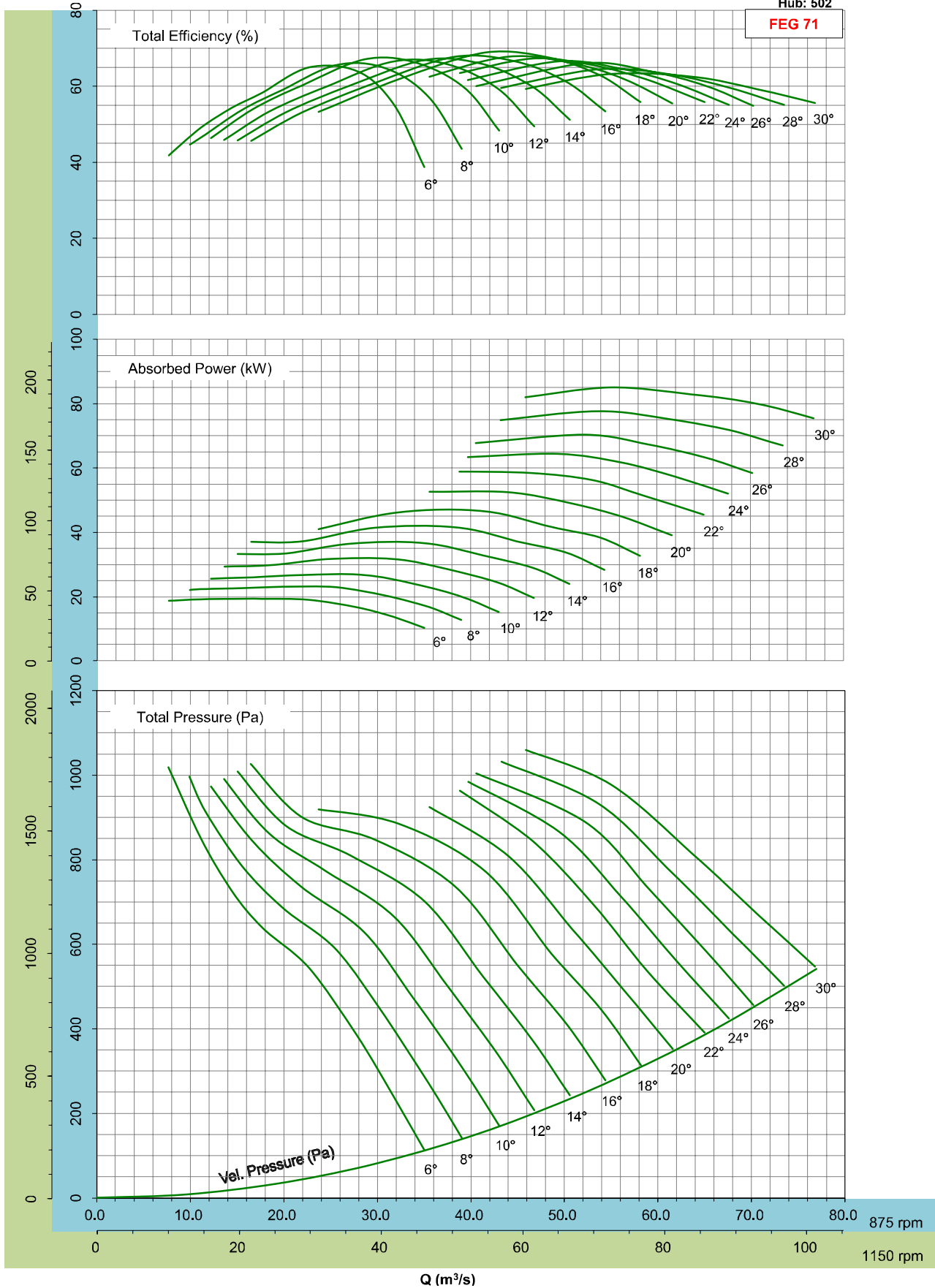

- Performance certified is for installation type D - ducted inlet, ducted outlet. Performance ratings do not include the effects of appurtenances (accessories).

- Please consult the nearest Kruger office for fan selection at 1750rpm.

TDA1800/31BM/8-8 60Hz



$\rho=1.2\text{kg/m}^3$
Hub: 502

FEG 71

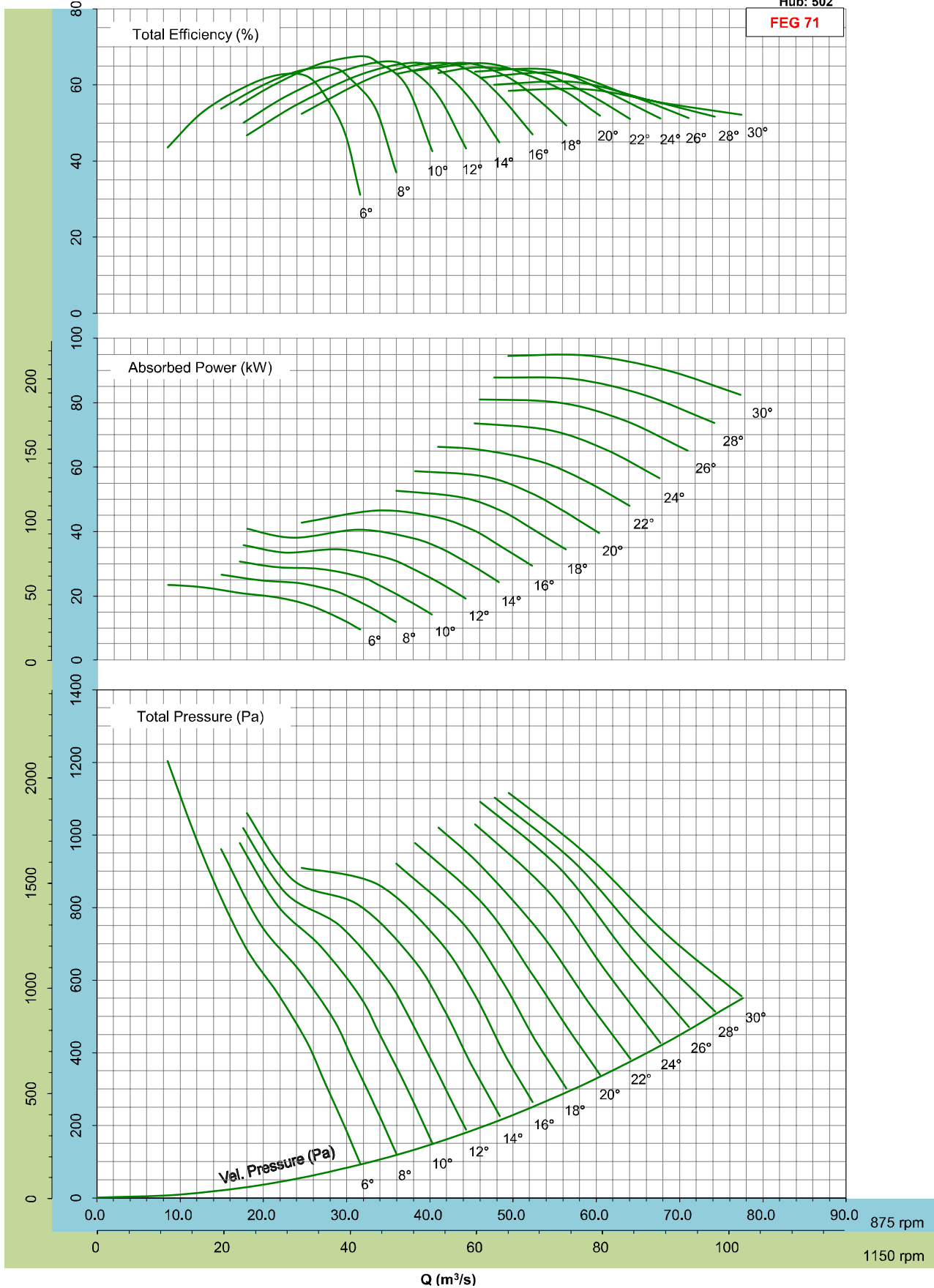

- Performance certified is for installation type D - ducted inlet, ducted outlet. Performance ratings do not include the effects of appurtenances (accessories).

- Please consult the nearest Kruger office for fan selection at 1750rpm.

TDA2000/31BN/4-4 60Hz



$\rho=1.2\text{kg/m}^3$
Hub: 560

FEG 71

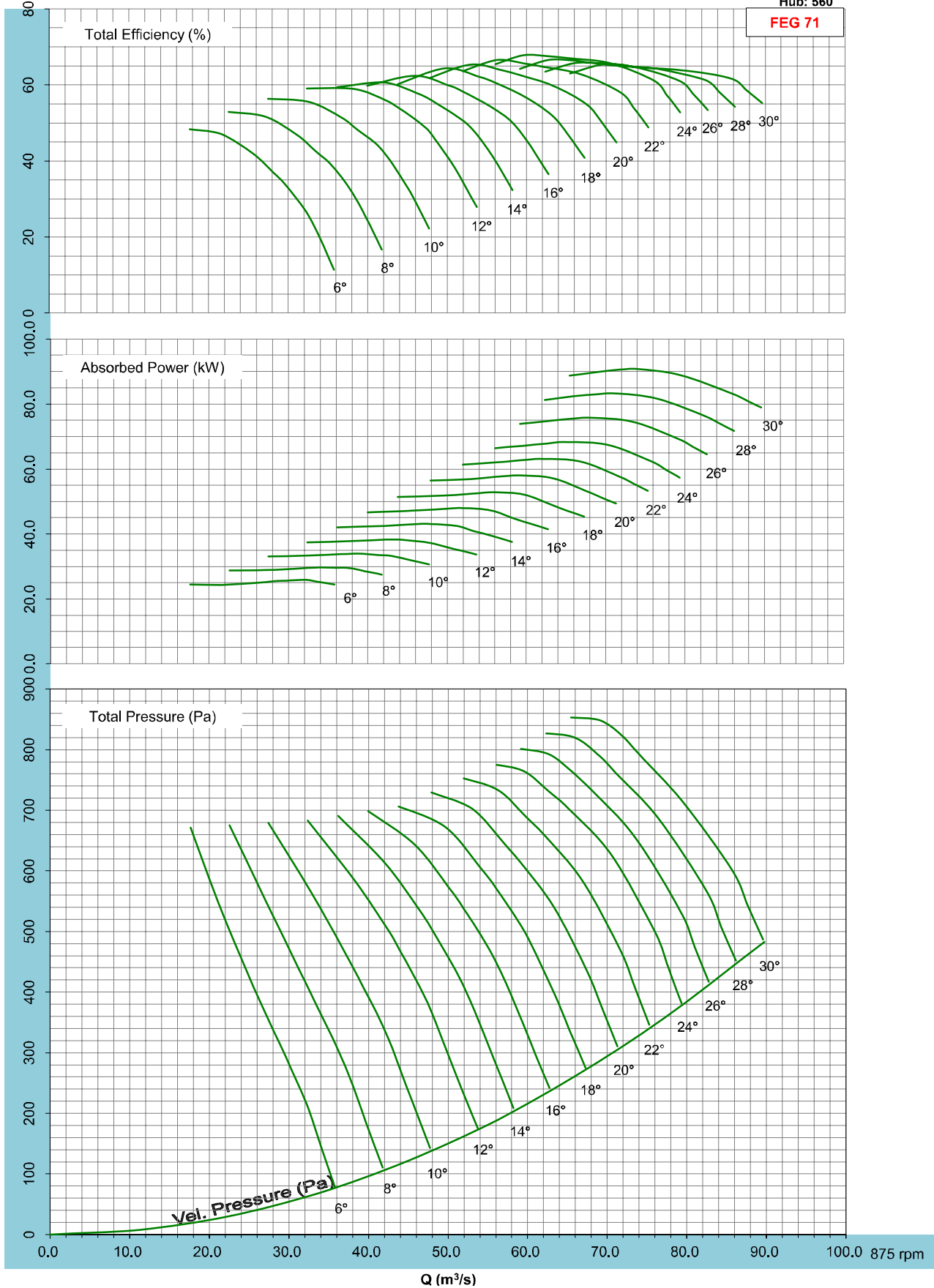

- Performance certified is for installation type D - ducted inlet, ducted outlet. Performance ratings do not include the effects of appurtenances (accessories).

- Please consult the nearest Kruger office for fan selection at 1750rpm.

TDA2000/31BN/6-6 60Hz



$\rho=1.2\text{kg/m}^3$
Hub: 560

FEG 71

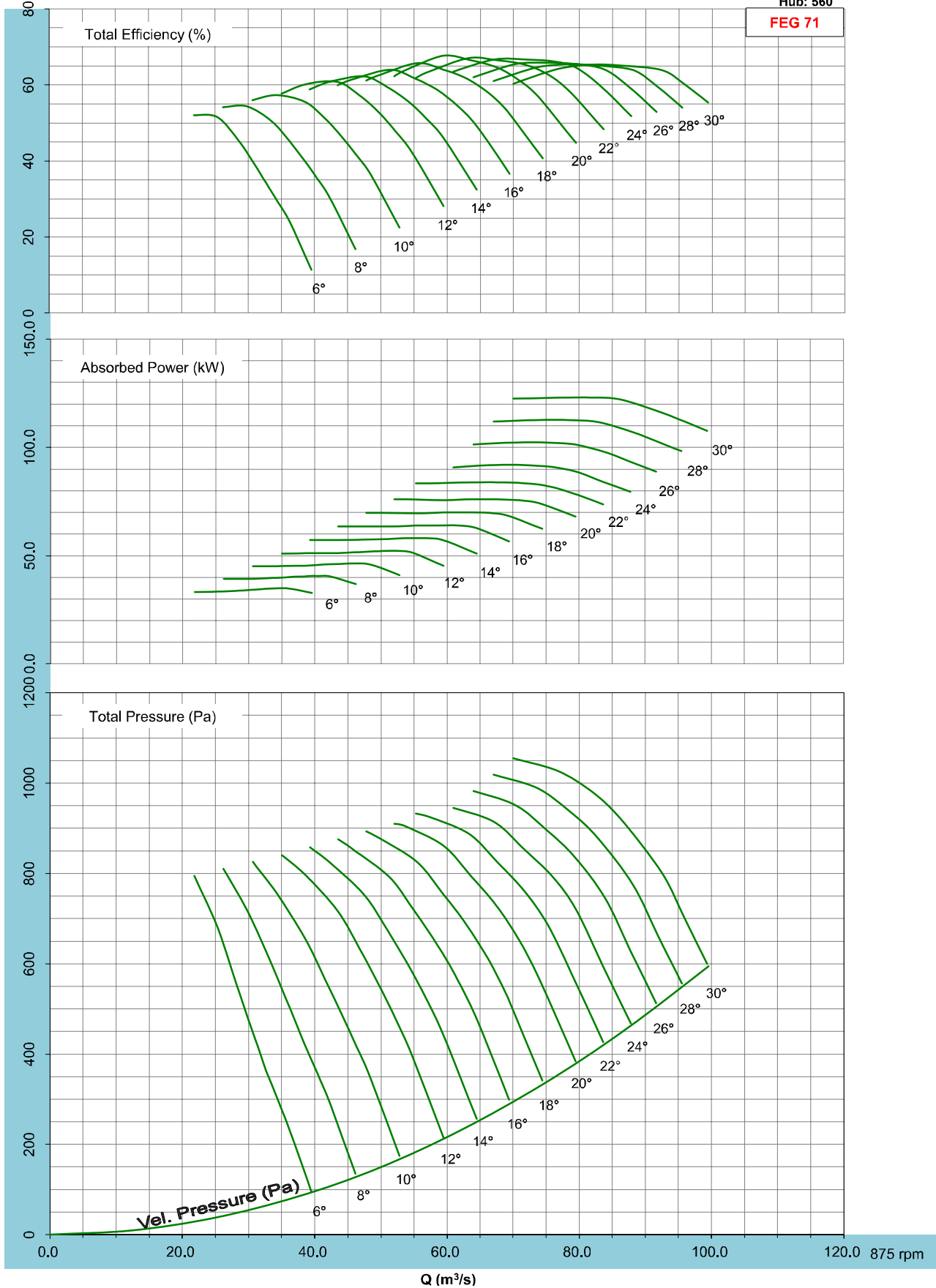

- Performance certified is for installation type D - ducted inlet, ducted outlet. Performance ratings do not include the effects of appurtenances (accessories).

- Please consult the nearest Kruger office for fan selection at 1750rpm.

TDA2000/31BN/8-8 60Hz



$\rho=1.2\text{kg/m}^3$
Hub: 560

FEG 71

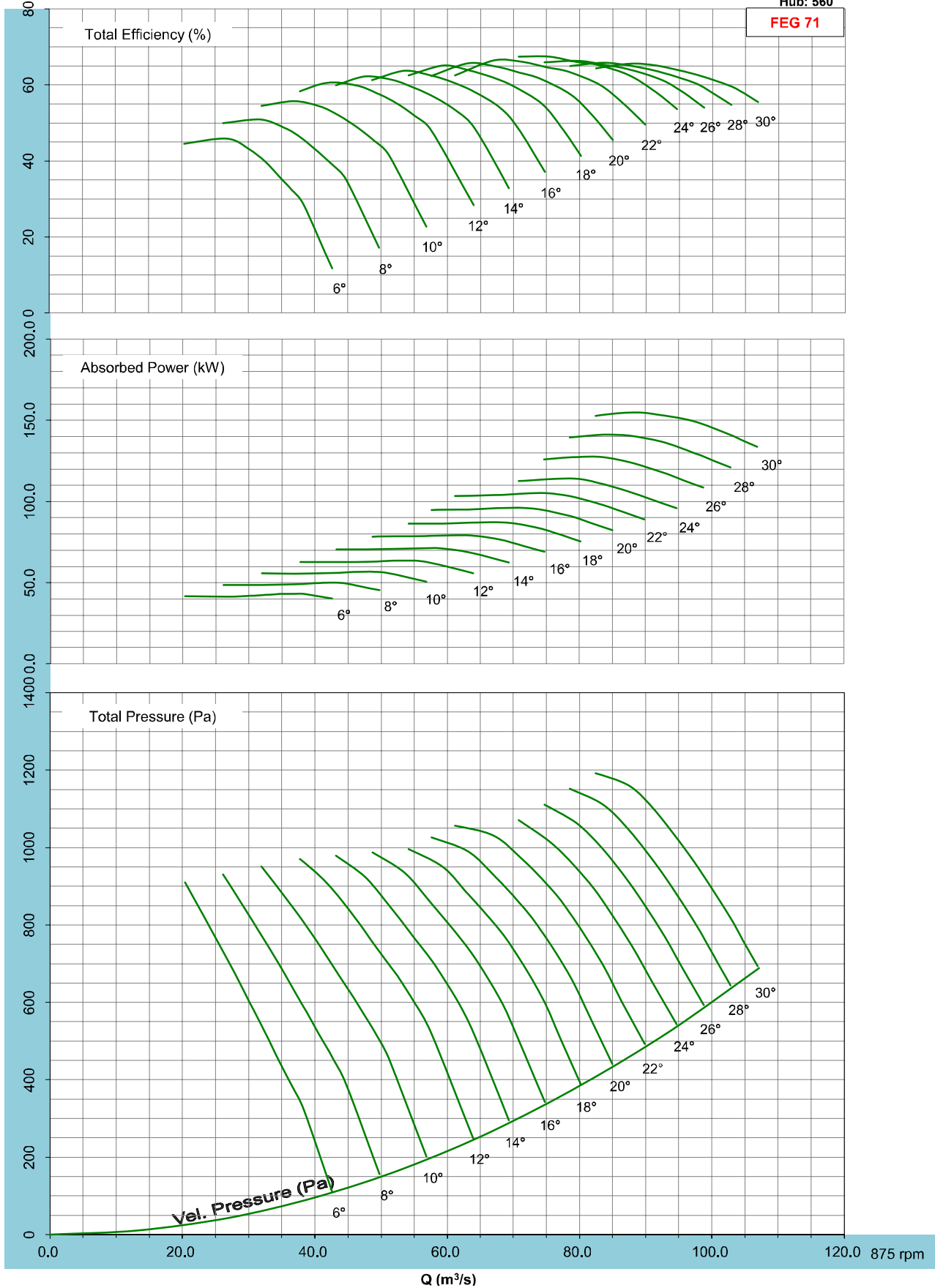

- Performance certified is for installation type D - ducted inlet, ducted outlet. Performance ratings do not include the effects of appurtenances (accessories).

- Please consult the nearest Kruger office for fan selection at 1750rpm.

NOTES

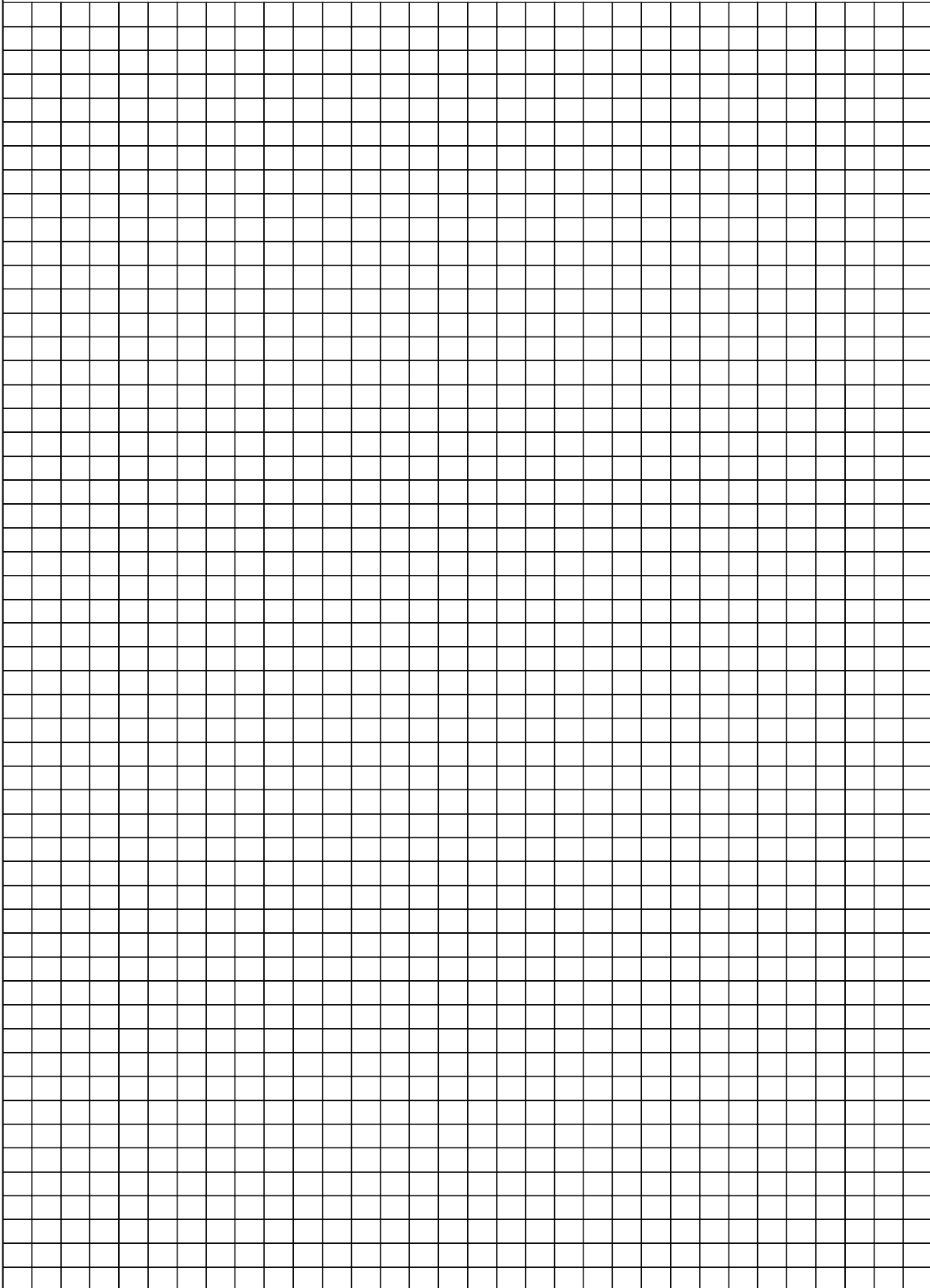

KRUGER GROUP (VENTILATION)

• THAILAND (Regional HQ)

KRUGER VENTILATION INDUSTRIES ASIA CO. LTD.

30/159 Moo 1, Sinsakorn Industrial Estate,
Chetsadawithi Road, Khok Kham Mueng, Samuthsakorn 74000, Thailand
Tel. +662 1054298 - Fax +662 0248256-9
Website: www.krugerfan.com

• CHINA (BEIJING)

BEIJING KRUGER VENTILATION CO. LTD

Level 7, A Block, Rising International Building, 29 JingHai San Road, BDA,
Beijing, P.R.China 100176
Tel. +86 10-67881366 - Fax +86 10-67880566
Email: krugertj@krugertj.com

• CHINA (SHANGHAI)

SHANGHAI KRUGER VENTILATION CO. LTD

No. 500 Yuanguo Road, Anting, Jiading,
Shanghai 201814 P.R. China
Tel. +86 21-69573266 - Fax +86 21-69573296
Email: shkruger@krugerchina.com

• CHINA (WUHAN)

WUHAN KRUGER VENTILATION CO. LTD

No. 805, Huian Ave, Dongxihu District, Wuhan, Hubei, P.R. China 430000
Tel. +86 27- 83248840/83060522/83097505
Fax +86 27- 83261886
Email: whkruger@krugerwh.com

• HONG KONG

KRUGER VENTILATION (HONG KONG) LIMITED

Flat C, 9/F, Yeung Yiu Chung (No.8) Industrial Building,
20 Wang Hoi Road, Kowloon Bay, Kowloon, Hong Kong
Tel. +852 22469182 - Fax +852 22469187
Email: info@kruger.com.hk

• INDIA (NORTH)

KRUGER VENTILATION INDUSTRIES (NORTH INDIA) PVT LTD

Plot No. - 191, Sector - 59, Ballabgarh, Faridabad - 121 004, Haryana, India
Tel. +91-9958991660/9717449696
Fax. +91-1294135820
Email: sales.kni@krugerindia.com

• KOREA

NEOMATE CO. LTD

2-1010, Ace High Tech City B/D, 775 Gyeongin-ro,
Yeongdeungpo-gu, Seoul, Korea. Postal Code 07299
Tel. +82-2-2679-2052 - Fax. +82-2-2679-2174
Email: y7890@neomate.co.kr

• MYANMAR

KRUGER VENTILATION (MYANMAR) CO.LTD

Room No. F21, Thiri Yadanar Whole Sale Market, (Htawunbe)
Toe Chae Ward, North Okkalapa Township, Yangon.
Tel. +959 763141081/2/3
Email: htoon@krugermm.com

• SINGAPORE

KRUGER ENGINEERING PTE LTD

No. 10 Buroh Street #06-06, West Connect Building,
Singapore 627564
Tel. +65 68631191 - Fax +65 68631151
Email: mktg@krugerasia.com

• THAILAND

KRUGER VENTILATION IND. (THAILAND) CO. LTD

30/105 Moo 1, Sinsakorn Industrial Estate,
Chetsadawithi Road, Khok Kham Mueng, Samuthsakorn 74000, Thailand
Tel. +662 1050399 - Fax + 662 1050370-2
Email: mktg@kruger.co.th

• AUSTRALIA

S&P-KRUGER AUSTRALIA PTY LTD

2 Cunningham St, Moorebank N.S.W. 2170
Tel. +61 2-98227747
Fax. +61 2-98227757
Email: info@sandpkruger.com.au

• CHINA (GUANGZHOU)

GUANGZHOU KRUGER VENTILATION CO. LTD

No. 9 Huahui Road, Huashan, Huadu,
Guangzhou, P.R. China 510880
Tel. +86 20-66356635 - Fax +86 20-86786001/86786500
Email: gzkruger@krugergz.com

• CHINA (TIANJIN)

TIANJIN KRUGER VENTILATION CO. LTD

No.168 Anyuan Road, Jingjin Science and Technology Park
Wuqing District, Tianjin, China
Tel. +86 22-22143480/3481 - Fax +86 22-22143482
Email: krugertj@krugertj.com

• DUBAI

KRUGER VENTILATION INDUSTRIES, GULF BRANCH

Jebel Ali Free Zone Area (JAFZA) P.O. Box No. 262949, Dubai, UAE
Tel. +971 4 8819188/8832017
Fax. +971 4 8832018
Email: johncs@krugerasia.com

• INDIA

KRUGER VENTILATION INDUSTRIES (INDIA) PVT LTD

Kruger Centre, Mumbai-Nasik Highway,
Kalangaon, Shahapur, Thane 421601, Maharashtra, India
Tel. +91 9960558899/9975577211 - Fax +91 2527 240075
Email: sales@krugerindia.com

• INDONESIA

P.T. KRUGER VENTILATION INDONESIA

JL. Teuku Umar No.20,
Karawaci - Tangerang 15115, Indonesia
Tel. +62 21-5512288/5513557 - Fax +62 21-5513502
Email: mktg@krugerindo.co.id

• MALAYSIA

KRUVENT INDUSTRIES (M) SDN BHD

Lot 850, Jalan Subang 7, Taman Perindustrian Subang,
47500, Subang Jaya, Selangor D.E.
Tel. +603 80743399 - Fax +603 80743388
Email: mktg@kruger.com.my

• PHILIPPINES

KRUGER M&E INDUSTRIES CORPORATION

FAPI Compound, E. Rodriguez Ave.
Tunasan, Muntinlupa City 1773, Philippines
Tel. +63 2-8622892/4/6/7, 5534059 - Fax +63 2-8622891
Email: mktg@krugerph.net

• TAIPEI

KRUGER VENTILATION (TAIWAN) CO. LTD

No. 157, Ping-an Rd, Hengfeng Village,
Dayuan Shiang Taoyuan County 337, Taiwan
Tel. +886 3-3859119 - Fax +886 3-3859118
Email: sales@krugertwn.com.tw

• VIETNAM

KRUGER VENTILATION INDUSTRIES (VIETNAM) CO. LTD

Lot A7. 2-4, C2 Road, Thanh Thanh Cong IZ,
Trang Bang Dist. Tay Ninh Province, Vietnam
Tel. +84-276 3585200/01/02 - Fax +84-276 3585199
Email: mktg@krugervn.com

The company is always improving and developing its products, therefore the company reserves the right of making changes to the illustrated products.
Certified dimension can be provided upon request.