



# *RDC Series*

**ROOF EXHAUST CENTRIFUGAL FAN**



# Roof Exhaust Centrifugal Fan – RDC Series

KRUGER

- Roof exhaust centrifugal fan are designed for air exhaust, mounted on the roof in vertical position, with radial and vertical air flow.
- Rainhood is made of fiberglass as protection against adverse weather conditions.
- Supported casing made of galvanised steel with protection grille to prevent contact with moving parts.
- Centrifugal backward curved impeller is made of galvanised sheet steel.
- All wheels are statically and dynamically balanced in accordance with ISO 1940 or AMCA204 - Grade G2.5 standard.
- Totally enclosed motor, IP54 protection with class F insulation.
- Standard motor up to 2.2kW are usually supplied on DOL starting, motor 3.0kW and above Star/Delta.
- Max temperature of air and fumes at temperature of 80 °C.
- Accessories such as backdraft damper are available upon request.

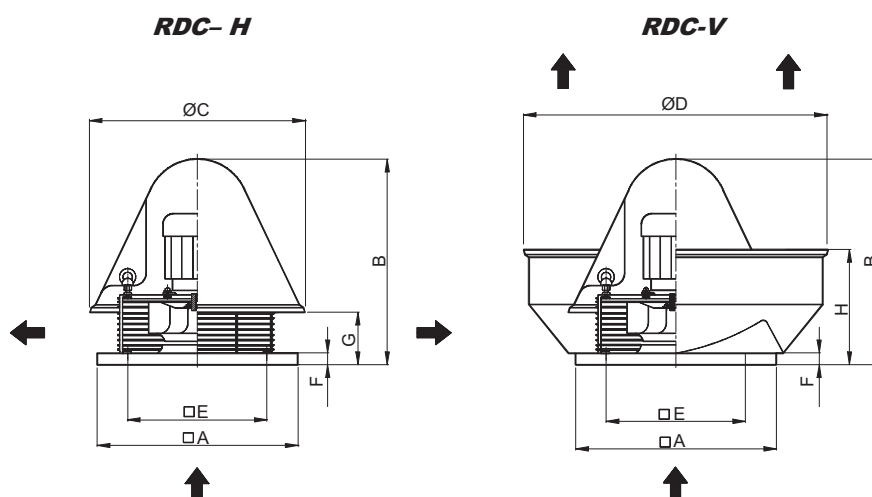

Model	A	B	ØC	ØD	E	F	G	H
RDC 400	514	584	651	826	464	38	219	345
RDC 450	760	740	932	1251	699	38	216	498
RDC 500	760	773	932	1251	699	38	250	498
RDC 560	760	813	932	1251	699	38	290	498
RDC 630	860	918	1090	1379	798	38	306	544
RDC 710	860	961	1090	1379	798	38	349	544
RDC 800	960	1077	1210	1526	898	38	378	588
RDC 900	1160	1244	1464	1986	1098	30	360	735
RDC 1000	1160	1294	1464	1986	1098	30	401	735

All dimensions in mm

## Technical Data – 50 Hz

Model	Max. air mov. m3/h	Phase	N° Poles	Power kW	Hz	dB (A) at 3m	RPM	RDC-H Weight (Kg)	RDC-V Weight (Kg)
RDC 400/4P	3200	3	4	0.37	50	60	1390	36	39
RDC 400/6P	2000	3	6	0.18	50	51	910	36	39
RDC 450/4P	4700	3	4	0.55	50	62	1405	49	56
RDC 450/6P	3000	3	6	0.25	50	55	910	52	58
RDC 500/4P	6500	3	4	1.10	50	64	1400	66	73
RDC 500/6P	4700	3	6	0.55	50	57	910	64	70
RDC 560/4P	8700	3	4	1.50	50	67	1405	73	80
RDC 560/6P	6800	3	6	0.75	50	60	935	71	77
RDC 630/6P	10600	3	6	1.10	50	63	935	77	85
RDC 710/6P	15000	3	6	2.20	50	66	950	103	112
RDC 800/6P	22000	3	6	4.00	50	69	955	161	171
RDC 900/6P	31000	3	6	7.50	50	71	970	240	251
RDC1000/6P	43000	3	6	11.0	50	73	970	286	302

## Technical Data – 60 Hz

Model	Max. air mov. m3/h	Phase	N° Poles	Power kW	Hz	dB (A) at 3m	RPM	RDC-H Weight (Kg)	RDC-V Weight (Kg)
RDC 400/6P	2500	3	6	0.25	60	56	1120	45	48
RDC 450/6P	3700	3	6	0.37	60	59	1120	55	61
RDC 500/6P	5800	3	6	0.75	60	61	1120	66	72
RDC 560/6P	8200	3	6	1.10	60	64	1130	74	80
RDC 630/6P	12800	3	6	1.50	60	67	1130	81	89
RDC 710/6P	18000	3	6	4.00	60	69	1150	127	136
RDC 800/6P	26500	3	6	5.50	60	72	1150	166	176
RDC 900/8P	27500	3	8	7.50	60	70	860	262	273
RDC1000/8P	38000	3	8	11.0	60	72	860	311	327

### Performance Data - 50 Hz

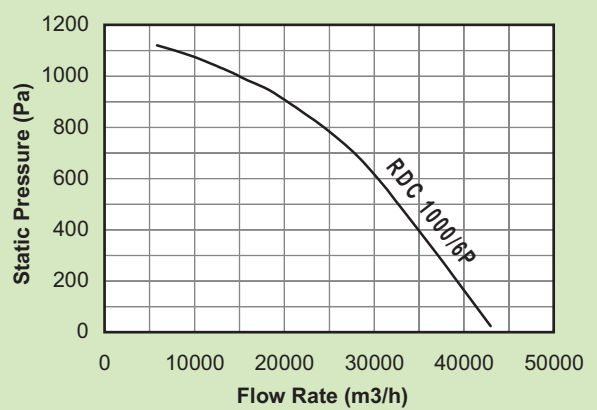
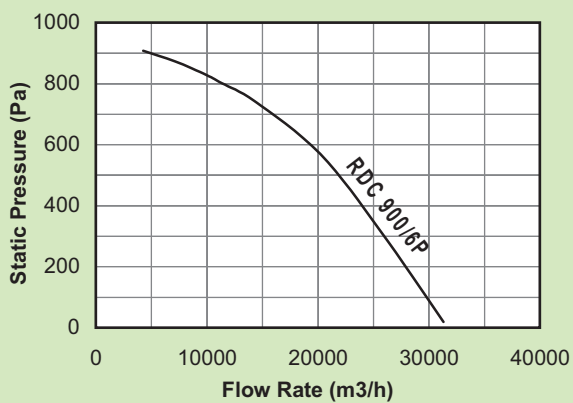
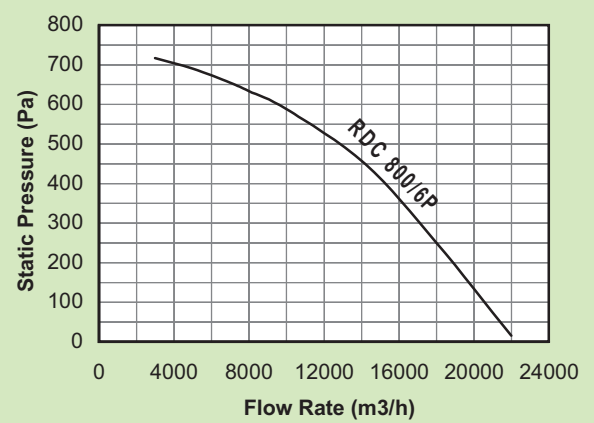
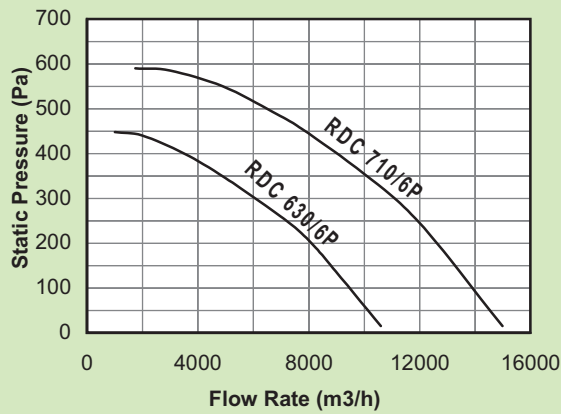
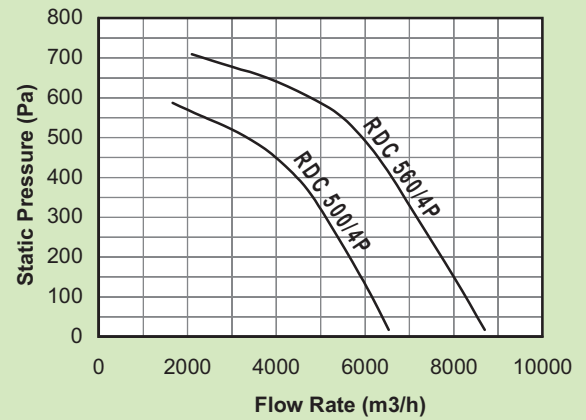
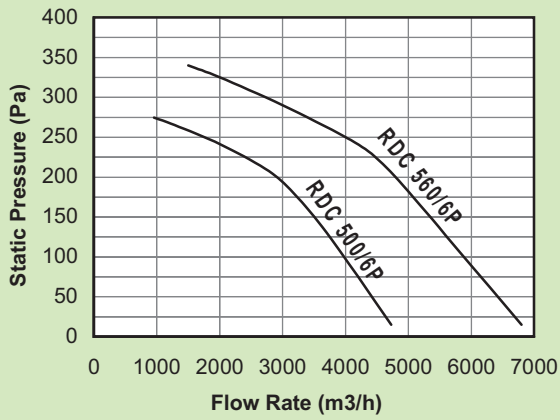
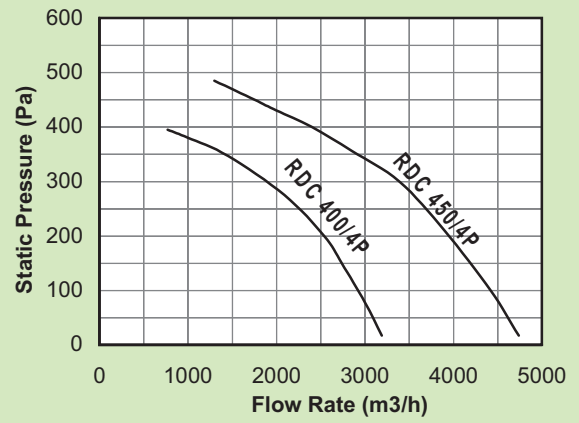
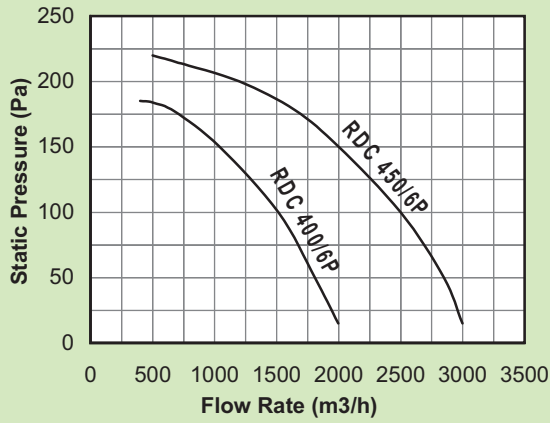

**Performance Data - 60 Hz**

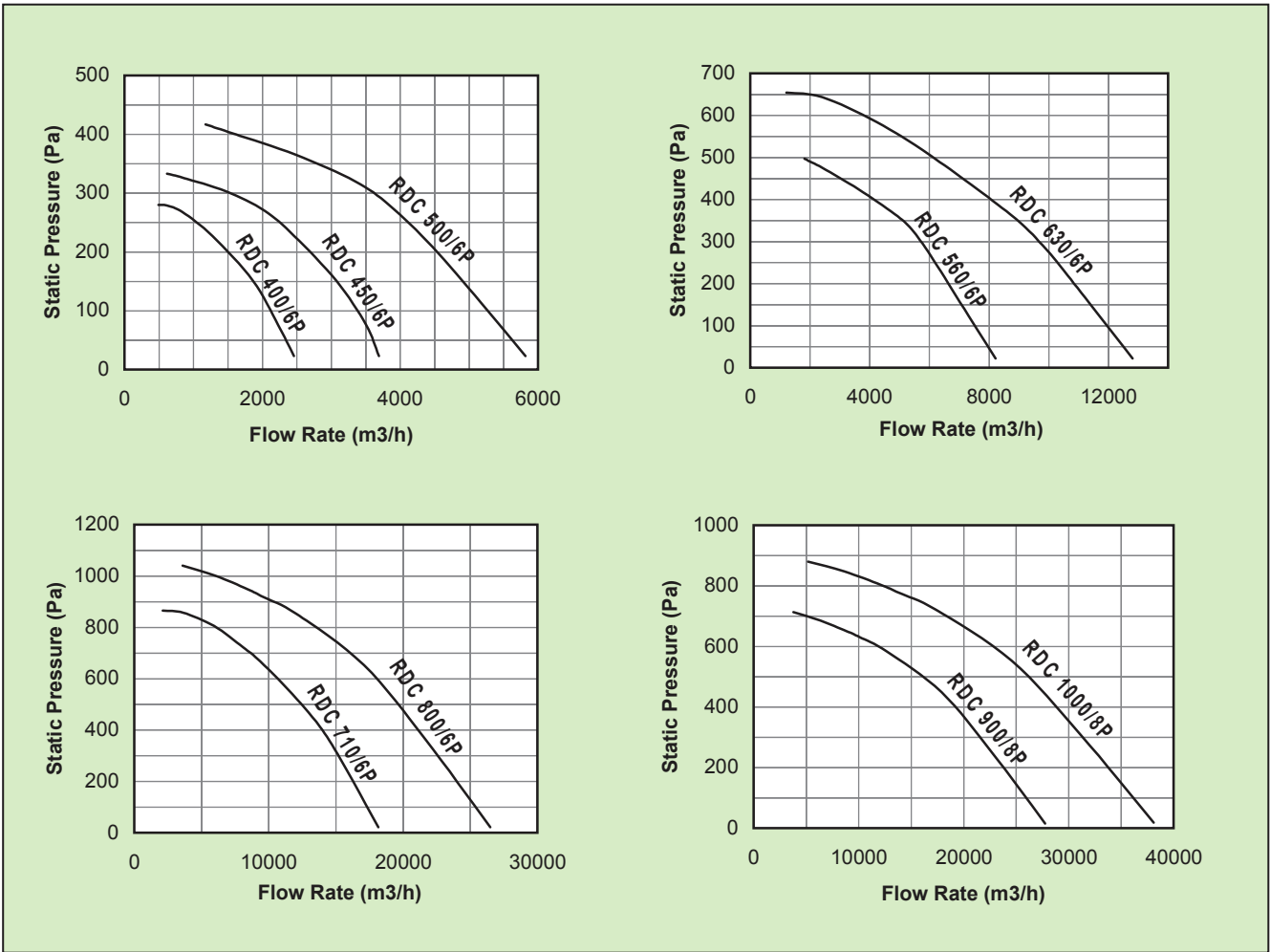

The company is always improving and developing its products, therefore the company reserves the right of making changes to the illustrated products. Certified dimension can be provided upon request.